

HCD

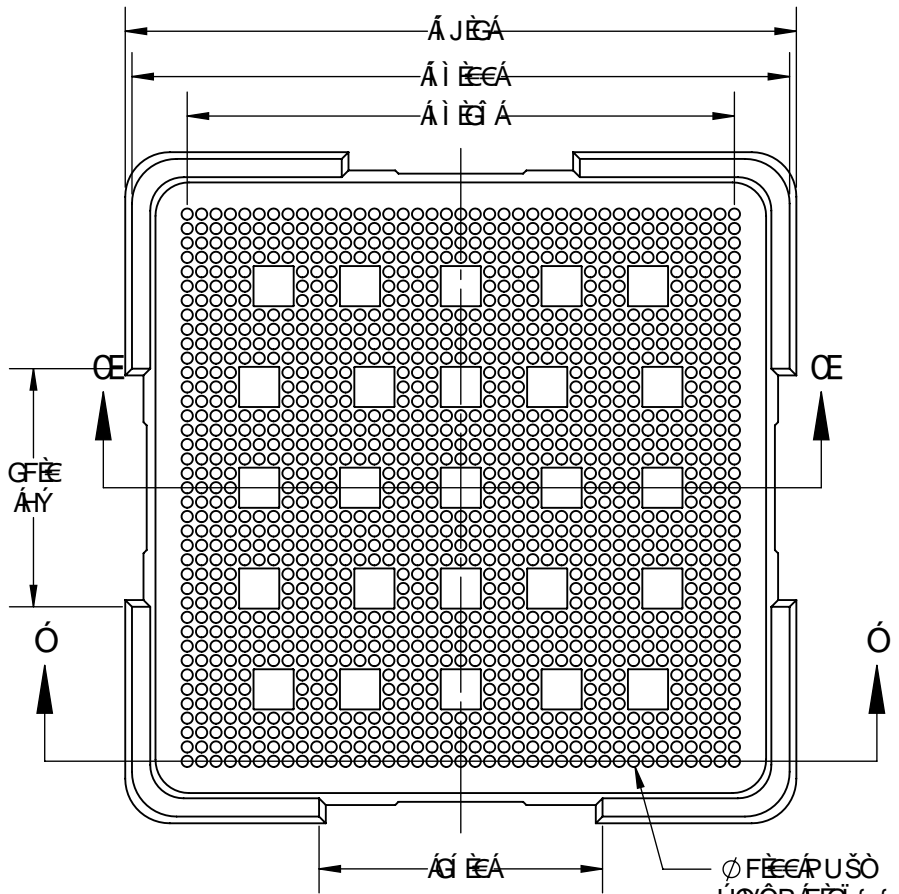

Ø F E E Á P U S Ò
 Ú Q Ó P Á F E I
 H U C H U Á T C E V Ú Q
 Ú Ó Ó Á Ó V C E S Á Ó

G89

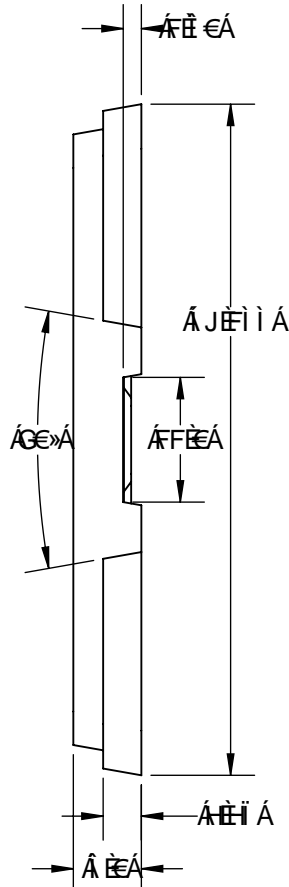

6 CHCA

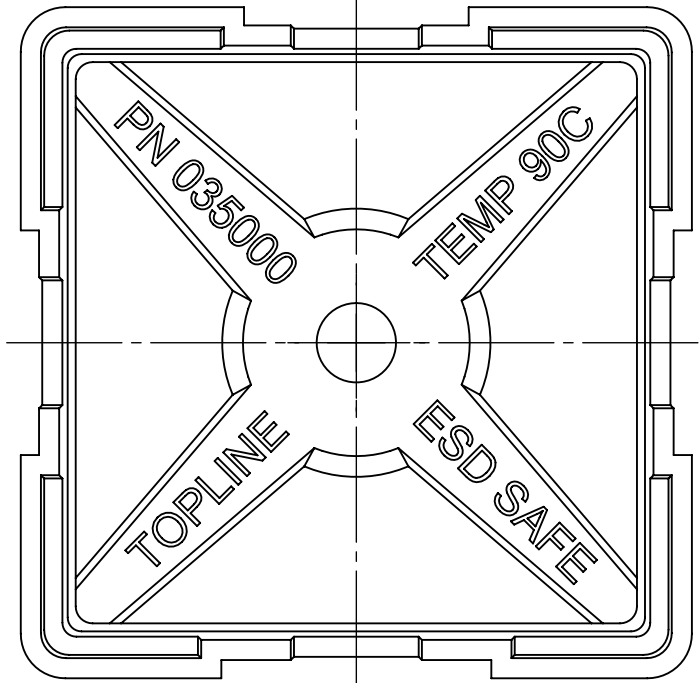

Ð U V Ò U K
 F E Ò Q Ò P Ò U Q P Á T È
 G Á T C E V Ò Ú C E S Á Ó P Ò W Ò V Q Ó Á U S Y Ó C E Ú Ó P C E V Ò È
 H E V Ò T Ú Ó Ú C E M Ò Ú Á I E Ó Á T C E Y È
 I È Ó U S Ò U K Ó S C Ó S È
 Í È Ó U Ó T C E P Ó P V Á Ú Ó Á Ú C Ó
 Á Á Á U W Ü C E Ó Ó Á Ú Ó Ú Q Q X Q Y Á È Á F È Ó È Á

Ú Ó Ó Á Ó V C E S Á Ó C E

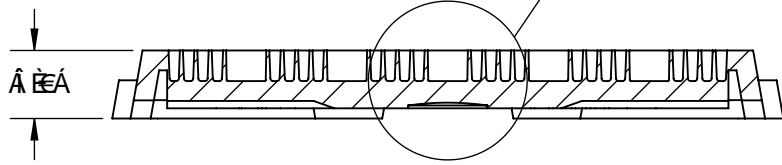

G97 HCB'5 I5

<table border="1"> <tr> <td>Ú Ó Ú Ó Ú X Ó S Ú</td> <td>Ó C V Ó</td> <td rowspan="3"> </td> <td colspan="3" rowspan="3"> V Q Ó S Ó Ó Ó Ó C Á P Q Ó Ú C S Ó C E Ú Ó Ú Ó Ú Q Ó P Á F E I T T </td> </tr> <tr> <td>Ó Ú C E Y P Á Á Á V I E E</td> <td>Ì B E B E G E</td> </tr> <tr> <td>Ò P Ó T È P # c</td> <td>Ì B E B E G E</td> </tr> </table>	Ú Ó Ú Ó Ú X Ó S Ú	Ó C V Ó		V Q Ó S Ó Ó Ó Ó C Á P Q Ó Ú C S Ó C E Ú Ó Ú Ó Ú Q Ó P Á F E I T T			Ó Ú C E Y P Á Á Á V I E E	Ì B E B E G E	Ò P Ó T È P # c	Ì B E B E G E	<table border="1"> <tr> <td>V U S Ó Ú C P Ó Ó</td> <td>T Ò Ó</td> <td>Ú Ó C S Ó</td> <td>Ú Ó Ó</td> <td>Ó Ú C E Y P Ó Á U È</td> <td>Ú Ó X</td> </tr> <tr> <td>Ý Á T</td> <td>Ú C E</td> <td>H G</td> <td>C E</td> <td>È Í È È È</td> <td>Ó</td> </tr> <tr> <td>Ý È Á Á È È È</td> <td>Ó W V</td> <td colspan="3">Ó U Á U V Á Ú Ó C S Ó Ó Ú C E Y P Ó</td> <td>Ú P Ó Ó V Á Ú Ó C Á</td> </tr> <tr> <td>Ý È Y Á Á È È È</td> <td>Ú Ó X Ó Ó Ó</td> <td colspan="3"></td> <td></td> </tr> </table>	V U S Ó Ú C P Ó Ó	T Ò Ó	Ú Ó C S Ó	Ú Ó Ó	Ó Ú C E Y P Ó Á U È	Ú Ó X	Ý Á T	Ú C E	H G	C E	È Í È È È	Ó	Ý È Á Á È È È	Ó W V	Ó U Á U V Á Ú Ó C S Ó Ó Ú C E Y P Ó			Ú P Ó Ó V Á Ú Ó C Á	Ý È Y Á Á È È È	Ú Ó X Ó Ó Ó				
Ú Ó Ú Ó Ú X Ó S Ú	Ó C V Ó						V Q Ó S Ó Ó Ó Ó C Á P Q Ó Ú C S Ó C E Ú Ó Ú Ó Ú Q Ó P Á F E I T T																												
Ó Ú C E Y P Á Á Á V I E E	Ì B E B E G E																																		
Ò P Ó T È P # c	Ì B E B E G E																																		
V U S Ó Ú C P Ó Ó	T Ò Ó	Ú Ó C S Ó	Ú Ó Ó	Ó Ú C E Y P Ó Á U È	Ú Ó X																														
Ý Á T	Ú C E	H G	C E	È Í È È È	Ó																														
Ý È Á Á È È È	Ó W V	Ó U Á U V Á Ú Ó C S Ó Ó Ú C E Y P Ó			Ú P Ó Ó V Á Ú Ó C Á																														
Ý È Y Á Á È È È	Ú Ó X Ó Ó Ó																																		

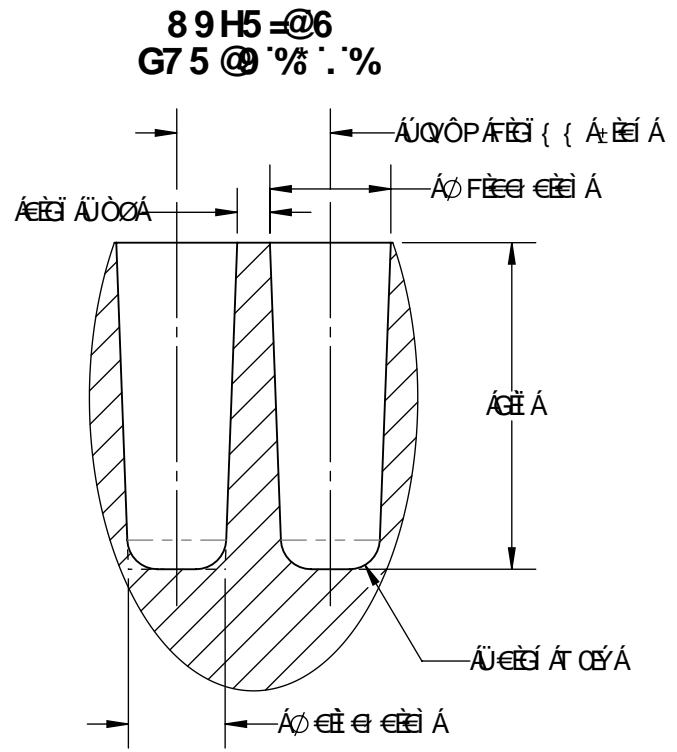
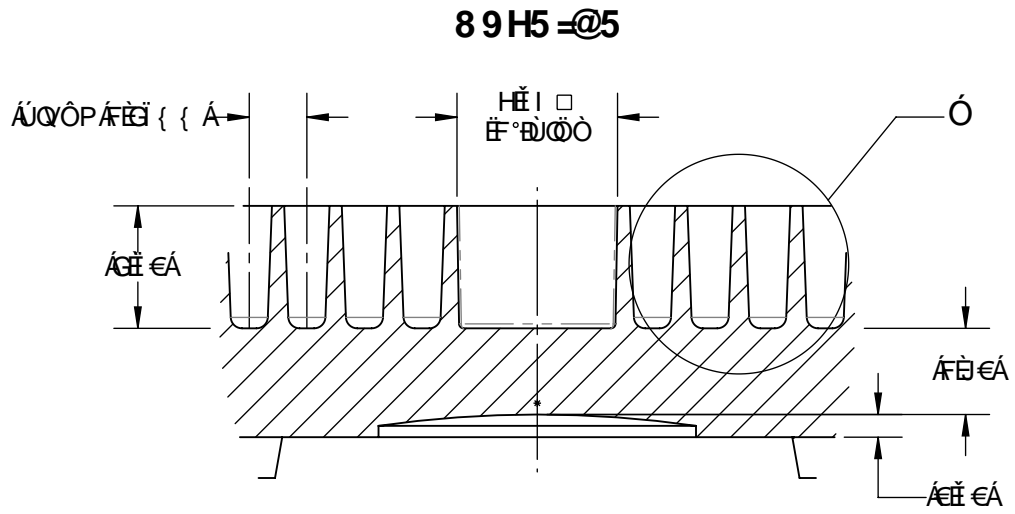

TopLine®			
ΕΠΙΧΕΙΡΗΣΙΑΚΗ ΕΤΑΙΡΙΑ ΑΥΘΟΠΑΓΕΓΓΙ Τ Τ			
ΟΔΟΣ Ι Κ	ΟΔΟΣ Ε	ΟΥΔΕΡΟΦΟΡΕ ΕΙ ΕΕΕ	ΟΔΟΣ Ο
ΟΥΔΕΡΟΦΟΡΕ ΟΥΔΕΡΟΦΟΡΕ			ΟΥΔΕΡΟΦΟΡΕ

89H5=@8

- **Á ĞĚ** { { ÁÔÔÔĚFÍ ĘJdFÍ GFÁT ĆVÛŲÁUϕHU
- **Á Ĩ ĚĚ** { { ÁÔÔÔĚĚ Ĩ Ĩ ÁT ĆVÛŲÁĜĚ ϕĜ
- **Á Ĩ** { { ÁÔÔÔĚĚ FÍ ÁT ĆVÛŲÁĜĚ ϕĜ
- **Á Ĩ** { { ÁÔÔÔĚĚ Ĩ ĜÁT ĆVÛŲÁĜĚ ϕĜ
- **Á ĨĚĚ** { { ÁÔÔÔĚĚ ĜĚ ÁT ĆVÛŲÁĜĚ ϕĜ
- **Á F** { { ÁÔÔÔĚĚ Ĩ Ĩ dĨ Ĩ Ĩ ÁT ĆVÛŲÁĜĚ ϕĜ
- **Á ĜJ** { { ÁÔÔÔĚĚ Ĩ Ĝd Ĩ Ĩ Ĩ ÁT ĆVÛŲÁĜĜϕĜĜ
- **Á Ĝ** { { ÁÔÔÔĚĚ Ĩ ĚÁT ĆVÛŲÁĜĜϕFJ
- **Á ĜF** { { ÁÔÔÔĚĚ Ĩ Ĩ ÁT ĆVÛŲÁĜĜĜFĨ

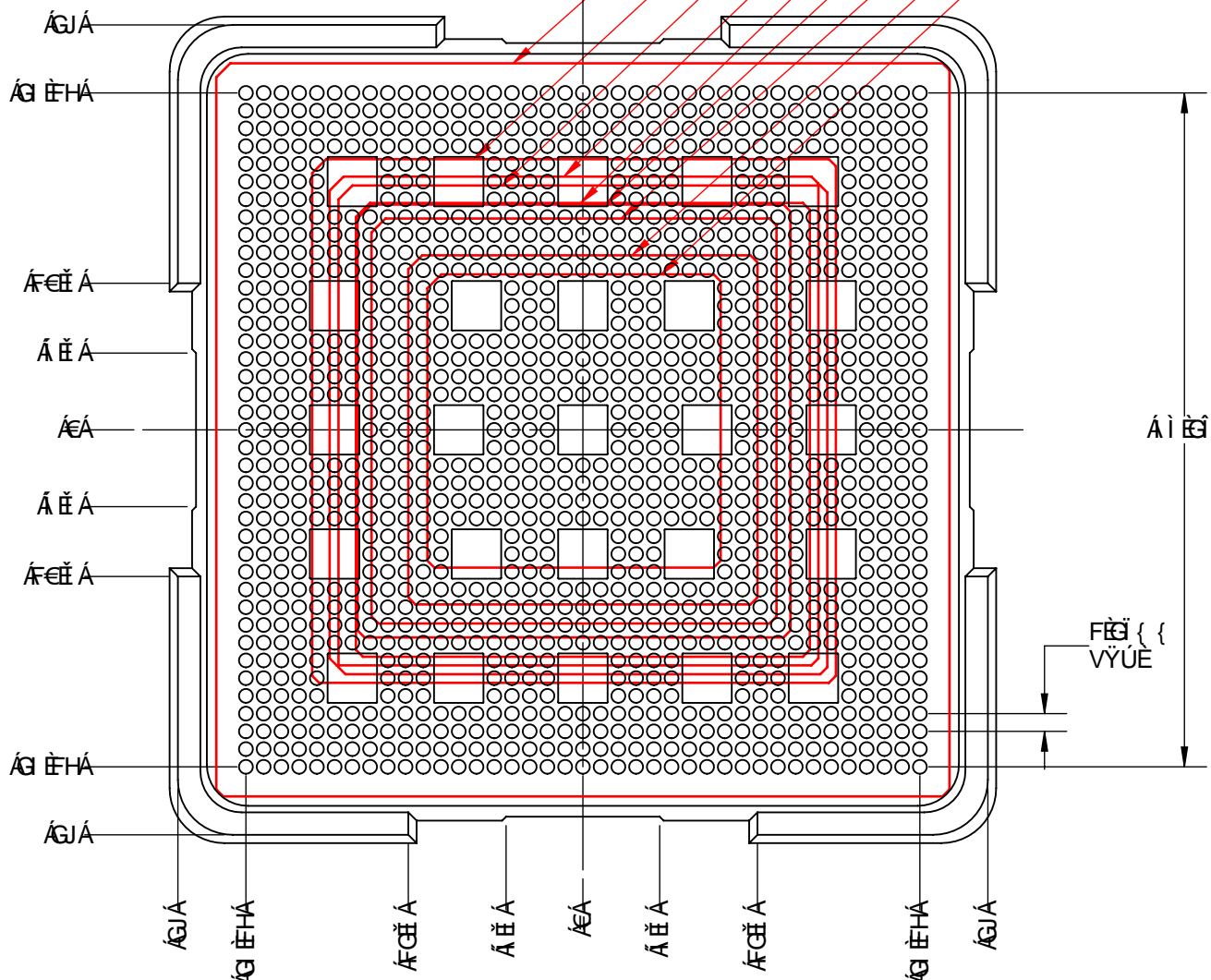

TopLine®			
VÁŲŠŌ ŌÔŌĚÁŲϕŌŲŪŲĚŠŌĚŪŲŌŲŪ ŪŲŲŲĜFĚĜ T T			
ŪŲĚŠŌ ĜF	ŪŲŌ ĆE	ŲŲĚŲ ϕŌĜŲĚ ĚĨ €€€	ŪŲĚ Ō
ŲŲĜŲŲŲŪŲŲĚŠŌŲŲĚŲ ϕŌ			ŪŲŌŲŲĜĜJŲĚÁ

G89 J9K
G95 HB; C: 77; 5 CB75 FF9F

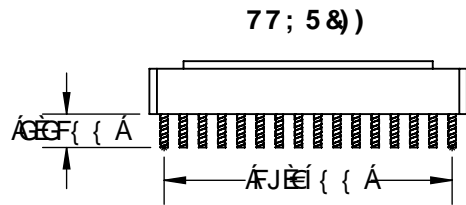

7C@ ABG%i%
&% &%a a

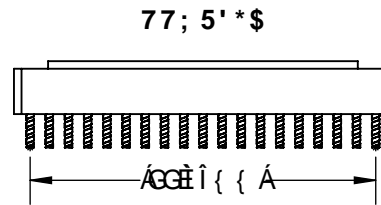

7C@ ABG%i%
&)l &)a a

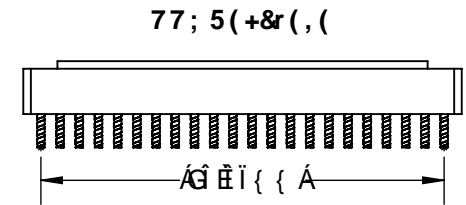

7C@ ABG&&l &&
&-l &-a a

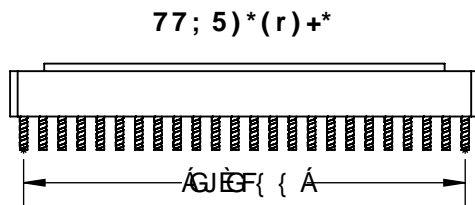

7C@ ABG&|l &
'% ' %a a

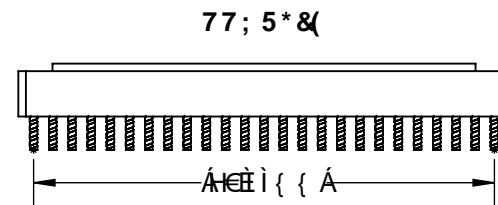

7C@ ABG&|l &
'&)'l' &)'a a

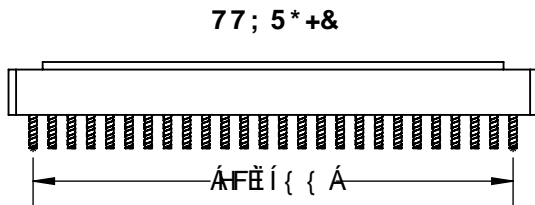

7C@ ABG&*|l &
'l')a a

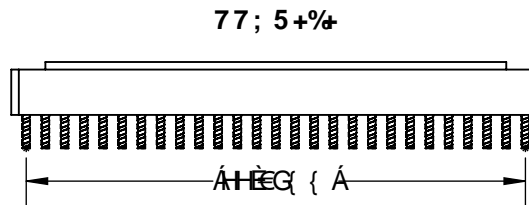

7C@ ABG&+|l &
'l')a a

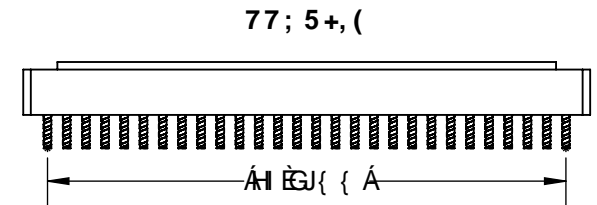

7C@ ABG&, |l &
'+'l' +')a a

77; 5%\$-r%&%

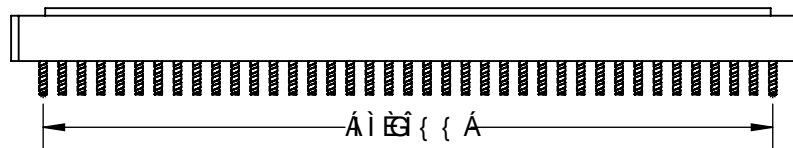

7C@ ABG"-l' -
)&)'l' &)'a a

PUV0UK
F&PUVAVU&U0AS0E

TopLine®			
V0AS0 O00&A#&X0U0ES00&U00U UQ0P&F&G TT			
U0AS0 GF	U0&0 CE	0U&A#&0&U&E E# €€€	U0X 0
0U&PUVAVU0AS00U&A#&0			U000V&AU&A

77; 5 'G=N9 'H5 6 @'
 7 C @ A B 'A5 HF L '5 B8 'HMD=7 5 @G=N9 'fA A L

A5 HF L		7 C @ A B G		G=N9
L	M	Bca	AU	Bca
FF	FF	FG€	FGF	Fí{ {
FG	FG	FI H	FI I	Fî{ {
FH	FH	Fî ì	Fî J	Fï{ {
FI	FI		FJÎ	Fì{ {
FÍ	FÍ		GÍ	FJ{ {
FÎ	FÎ	GÍ	GÎ	GF{ {
FÏ	FÏ		GÏ J	GH{ {
FÌ	FÌ		HG	GH{ {
FJ	FJ	Hí €	HÍ F	G{ {
G€	G€		I€€	G{ {
GF	GF		IIF	G{ {
GG	GG	IÏ G	IÏ I	G{ {
GH	GH		Í GJ	HF{ {
G	G	Á	í î ï	HF{ {
G	G	î G	î G	HG{ {

A5 HF L		7 C @ A B G		G=N9
L	M	Bca	AU	Bca
G	G		î î î	H{ {
G	G	ï Fï	ï GJ	H{ {
G	G		ï ì I	Hï È{ {
GJ	GJ		ì I F	Hï È{ {
H€	H€		J€€	I €{ {
HF	HF		JÍ F	I €{ {
HG	HG		F€G	I G€{ {
HH	HH	F€ï	F€ J	I G€{ {
H	H		FFÍ Î	I Í{ {
H	H		FGÍ	I Í{ {
H	H		FGÍ	I Î È{ {
H	H		FHÍ J	I Î È{ {
H	H		FI I I	I €{ {
HU	HU	Á	FÍ GF	I G€{ {

BCH9G.
 %'7 CBH57 H'HCD@B9': CF'CH<9F'G=N9G"
 &"F97H5B; I @ F'D57?5; 9'5 @CK98"

TopLine®			
vαršō ōōōzαpαxōūūcšōōūūōū ūqōpαfēg t t			
ūōcšō î K	ūzō €	ōūay αōāuē €í €€€	ūōx ō
ōuāuvāūōcšōōūay αō			ūpōōvā ūzā

AC89@
HCD

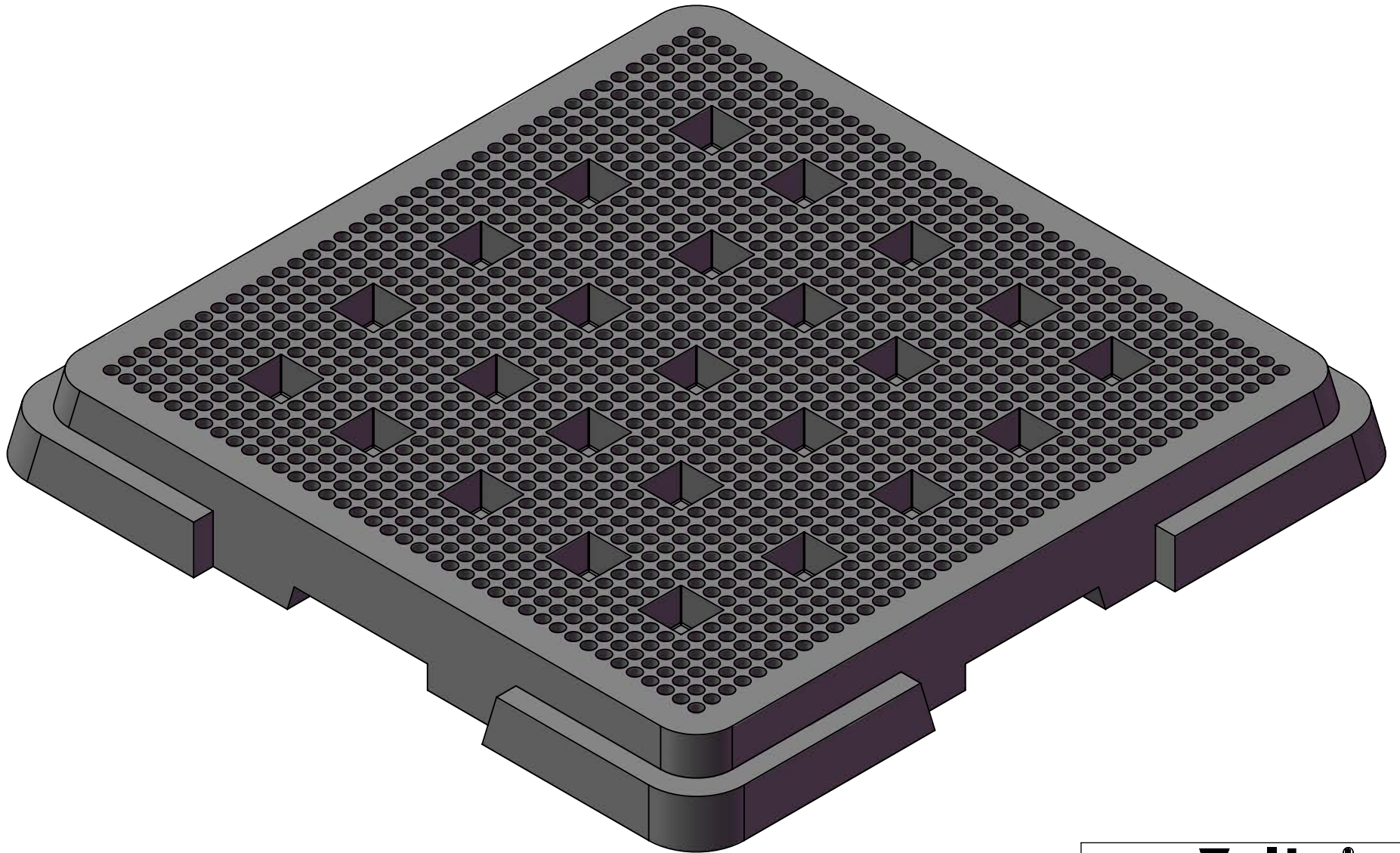

TopLine®			
ναισο οοοοαπφουοεσάοεπύοü υοαεσο υαο ούαεφοφουε ύοx			
HF	CE	ΕΙ €€€	Ο
ουφουναύοαεσοφούαεφο			ύποοβά άυαά

AC89@
6CHCA

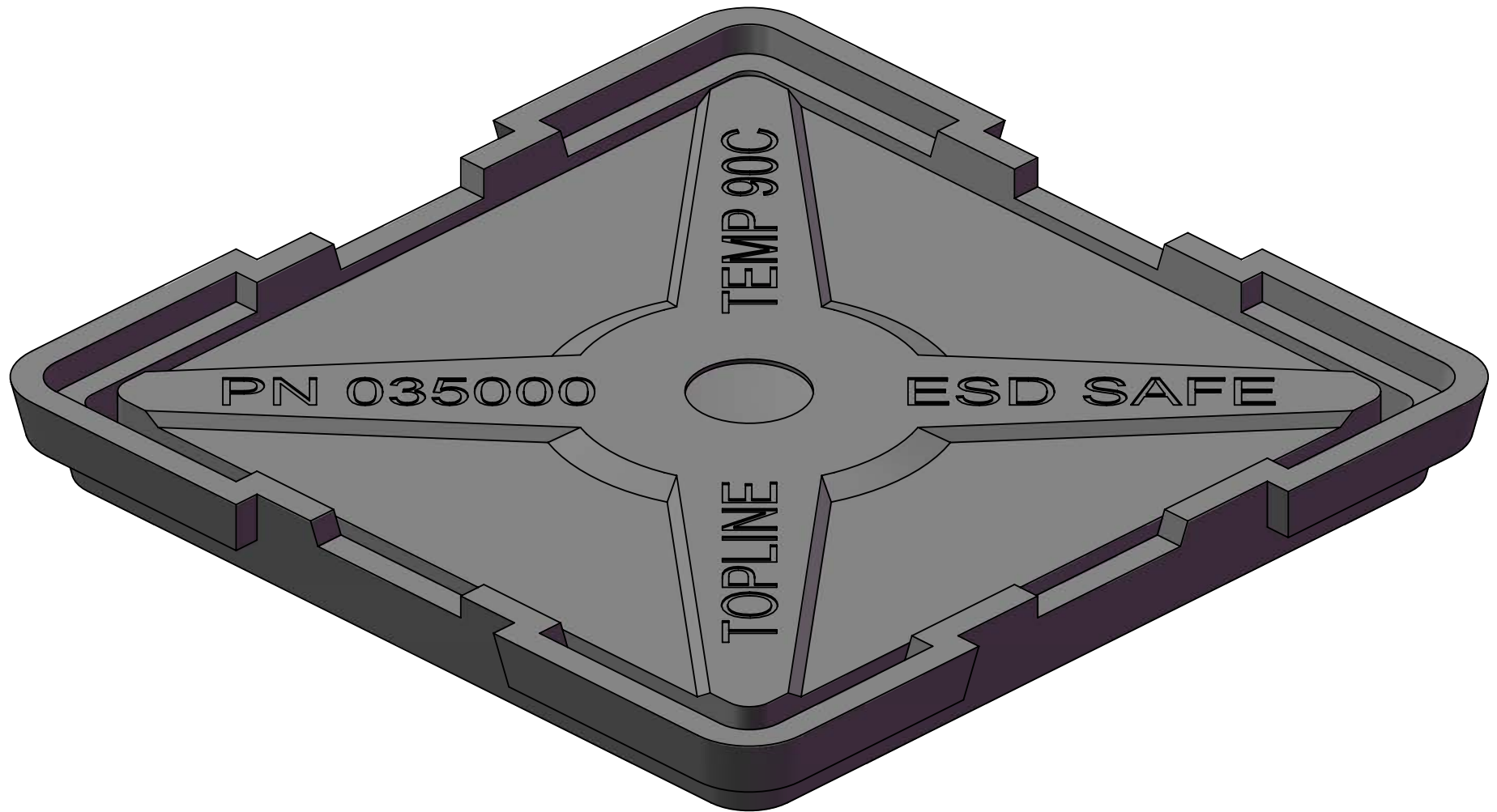

TopLine®			
ΠΡΩΤΗ ΕΠΙΧΕΙΡΗΣΙΑΚΗ ΕΤΑΙΡΙΑ			
ΥΠΟΛΟΓΙΣΤΕΡΑ	ΥΠΟΛΟΓΙΣΤΕΡΑ	ΥΠΟΛΟΓΙΣΤΕΡΑ	ΥΠΟΛΟΓΙΣΤΕΡΑ
HF	CE	ΕΙΣΤΕ	Ο
ΕΠΙΧΕΙΡΗΣΙΑΚΗ ΕΤΑΙΡΙΑ			ΥΠΟΛΟΓΙΣΤΕΡΑ

CDHCB5 @
 77; 5 HF5 M6 CL GMGH9 A
 %&+A A D=H7 <

8 K; '\$- \$\$\$%'
 : C5A '%\$)'r '%\$''

8 K; '\$) \$\$\$
 75 FF=9F'
 %\$('r '%\$''

8 K; '% \$%'\$
 =BG9FH'%'('r '%\$)

71 GHCA9F
 @ 69 @

8 K; '\$- \$\$\$'
 : C5A '%\$)'r '%\$''

8 K; '\$- \$\$\$)
 65 B8 '%\$)'r '%\$''

8 K; '\$- \$\$\$-
 @ 69 @ '%\$''

8 K; '\$- \$* &
 6 CL '%\$)'r '%\$''



7 @CG98 '6 CL



TopLine®			
vαrσó ÔÔÔÇΑΠ=αΧÔÛÛËΣ'ΑÔÇÛÛÔÛ UQOPAFEG T T			
Uóαsó FIG	Uαzó CE	ÔÛαÿ αÔÁUÉ € € € €	Uòx CE
ÔUÁU VÁUÓαsóÔÛαÿ αÔ			ÛPÔÔVÁ ÁUÇÁ