

CCGA

Column Grid Array

PRODUCT GUIDE

2023-B

**HIGH
RELIABILITY!**



www.CCGA.co

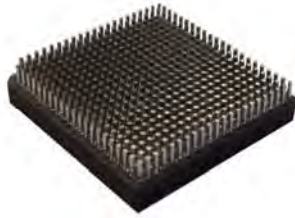

CCGA Packages
Page 4

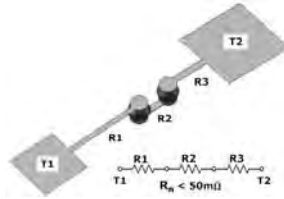

Daisy Chain Pattern
Page 5



Package Styles
Page 6 ~7



Al-SiC Heat Spreader
Page 8

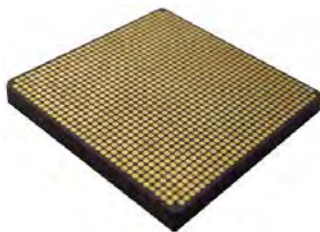

CLGA
Page 10 ~11



Pb80/Sn20
Cu Wrap Columns
Page 14



Pb90/Sn10
Plain Columns
Page 15



OFE - CDA101
Copper Columns
Page 16



Pb90/Sn10
Cu Wrap Columns
Page 17



Micro-Coil Springs
Invented by NASA
Page 18 ~ 19

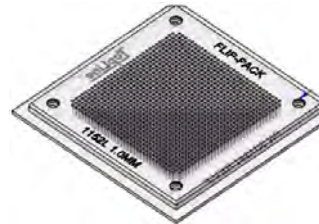

FLIP-PACK®
Loaded with Columns
Page 20 ~21

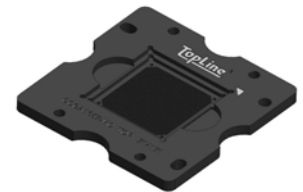

Graphite Tool Set
Column Attachment
Page 22 ~ 24

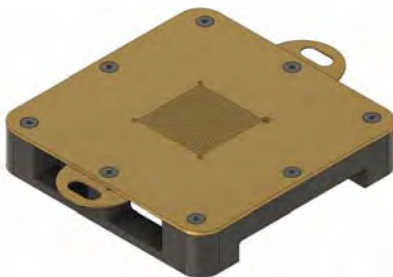

Column Trim &
Planarizing
Page 28 ~ 29



Tray
Transport & Storage
Page 30~ 31

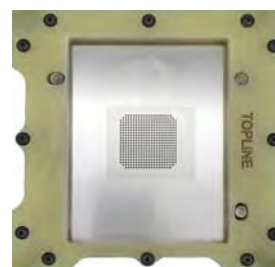

Alignment Tool
Page 25

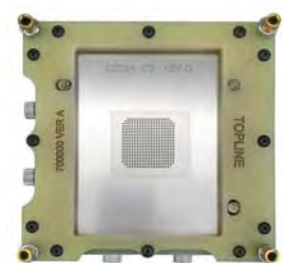

Solder Paste
Printer & Stencils
Page 27



About CCGA

Column Grid Array

Telephone:
+1-800-776-9888

About TopLine:

TopLine manufactures a wide range of daisy chain CCGA packages, columns and tools to attach columns to LGA packages. TopLine was founded in 1989.

CCGA (Also called CGA - Column Grid Array):

Solder columns are compliant and will absorb stress caused by CTE mismatch between large ceramic CCGA substrates (module) and the FR4 PCB board. CCGA packages are more reliable than BGA Ball Grid Arrays. CCGA packages can withstand stress, shock and harsh operating environments. Solder columns can also be attached to plastic packages to extend operating life.

Daisy Chain:

Daisy Chain is used to detect the onset of failures in CCGA package. In normal conditions, daisy chain circuits have low ohms resistance measured at test points on the PCB board. After the test vehicle PCB board is subjected to harsh conditions, such as vibrating and temperature cycling, an open circuit (or significant change in resistance) will indicate a failure. Typical failures are caused by a poor solder joint at the pads or a broken column.

Column Attachment Tools:

TopLine manufactures column attachment tools so you can attach columns to CCGA packages in your own facility. US Patents: D808350, D874413 and D908648)

Export:

ECCN: EAR99 Export Administration Regulations.
HS Code: 8542.90.0000
Electronic Integrated Circuits and Microassembly Parts
Daisy chain CCGA, columns and tools are not ITAR restricted.

Availability:

TopLine ships products worldwide. Contact an authorized TopLine distributor to assist you. We ship via UPS, FedEx, DHL or your specified courier.

Solder Columns:

TopLine manufactures many types of solder columns to comply with a full range of applications including original version Pb80/Sn20 copper wrap and Pb90/Sn10 plain columns. TopLine also makes new type copper columns and Copper Braided Columns (US Patent 10,477,698) with low thermal resistance for better heat dissipation. (US Patent 10,937,752)

Micro-coil Springs:

TopLine makes a new type of interconnect that was invented by engineers at NASA for applications requiring long term survivability. Micro-coil Springs have been tested in the lab to absorb 50,000G shock. NASA granted an exclusive license to TopLine under U.S. Patent Application Serial No. 13/800,692 entitled Interconnect Device and Assemblies.

Flip-Pack[®] (US Patent 9,629,259)

Pin-Pack[®] (US Patent 9,108,262)

Pre-loaded cassettes with solder columns allows quick attachment. The column matrix matches the array of your package. Columns are held in place by covers. Just remove the covers, and the columns gently load into the column attachment tools without vibration or vacuum. The empty Flip-Pack can be re-filled or used as a carrier to protect the CCGA package during storage or transport.

Contact:

TopLine Corporation

95 Highway 22 W.
Milledgeville, GA 31061 USA

Tel: +1-800-776-9888

Email: info@TopLine.tv
www.CCGA.co

We accept credit cards:



Pins Nbr	Matrix Array	Pitch	Size	Die	Fig	CCGA Part Number	Column Type
----------	--------------	-------	------	-----	-----	------------------	-------------



Pb80/Sn20 Column - Copper Wrap

483	22x22	1.0mm	23mm	Inside	1	CCGA483T1.0-DC225D	 <p>Column Pb80/Sn20 Copper Wrap</p>
624	25x25	1.27mm	32.5mm	Inside	2	CCGA624T1.27-DC254D	
717	27x27	1.27mm	35mm	Inside	3	CCGA717T1.27-DC275D	
896	30x30	1.0mm	31mm	Inside	4	CCGA896T1.0-DC308D	
1140	34x34	1.0mm	35mm	Surface	5	CCGA1140T1.0-DC345CN	
1144	34x34	1.0mm	35mm	Surface	6	CCGA1144T1.0-DC348CN	
1152	34x34	1.0mm	35mm	Inside	7	CCGA1152T1.0-DC346D	
1272	36x36	1.0mm	37.5mm	Inside	8	CCGA1272T1.0-DC367D	
1657	41x41	1.0mm	42.5mm	Surface	9	CCGA1657T1.0-DC417D	
1752	42x42	1.0mm	45mm	Surface	10	CCGA1752T1.0-DC427CN	

Pb90/Sn10 - Plain Column

483	22x22	1.0mm	23mm	Inside	1	CCGA483A1.0-DC225D	 <p>Column Pb90/Sn10 Plain Column</p> <p>Code "A"</p>
624	25x25	1.27mm	32.5mm	Inside	2	CCGA624T1.27A-DC254D	
717	27x27	1.27mm	35mm	Inside	3	CCGA717T1.27A-DC275D	
1140	34x34	1.0mm	35mm	Surface	5	CCGA1140T1.0A-DC345CN	
1144	34x34	1.0mm	35mm	Surface	6	CCGA1144T1.0A-DC348CN	
1152	34x34	1.0mm	35mm	Inside	7	CCGA1152T1.0A-DC346D	
1272	36x36	1.0mm	37.5mm	Inside	8	CCGA1272T1.0A-DC367D	
1657	41x41	1.0mm	42.5mm	Surface	9	CCGA1657T1.0A-DC417D	
1752	42x42	1.0mm	45mm	Surface	10	CCGA1752T1.0A-DC427CN	

Micro Coil Spring

483	22x22	1.0mm	23mm	Inside	1	CCGA483T1.0M-DC225D	 <p>Micro-Coil SnPb Plated Code "M"</p>  <p>Micro-Coil Gold Plated Code "G"</p>
624	25x25	1.27mm	32.5mm	Inside	2	CCGA624T1.27M-DC254D	
717	27x27	1.27mm	35mm	Inside	3	CCGA717T1.27M-DC275D	
1140	34x34	1.0mm	35mm	Surface	5	CCGA1140T1.0M-DC345CN	
1144	34x34	1.0mm	35mm	Surface	6	CCGA1144T1.0M-DC348CN	
1152	34x34	1.0mm	35mm	Inside	7	CCGA1152T1.0M-DC346D	
1272	36x36	1.0mm	37.5mm	Inside	8	CCGA1272T1.0M-DC367D	
1657	41x41	1.0mm	42.5mm	Surface	9	CCGA1657T1.0M-DC417D	
1752	42x42	1.0mm	45mm	Surface	10	CCGA1752T1.0M-DC427CN	

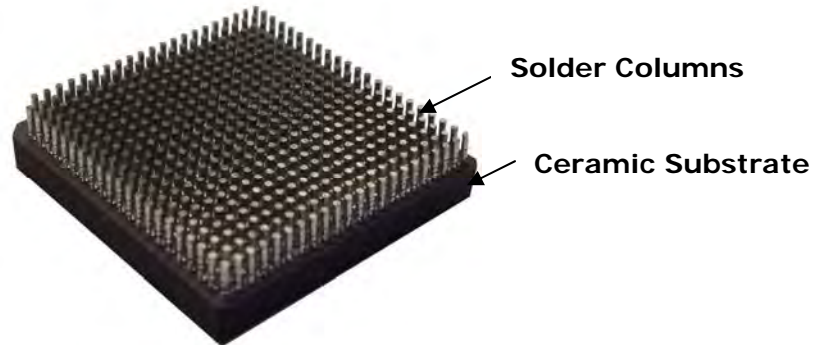

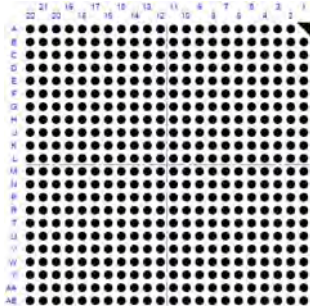

Fig. 1
CCGA483



Fig. 2.
CCGA624

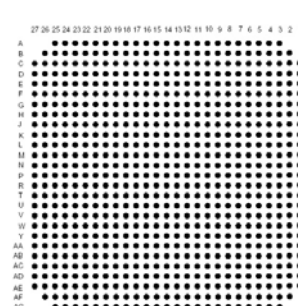

Fig. 3.
CCGA717

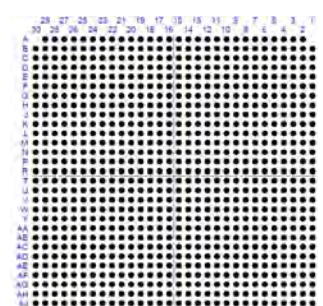

Fig. 4.
CCGA896

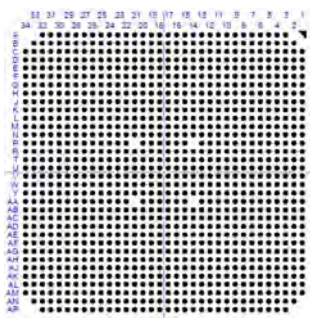

Fig. 5
CCGA1140

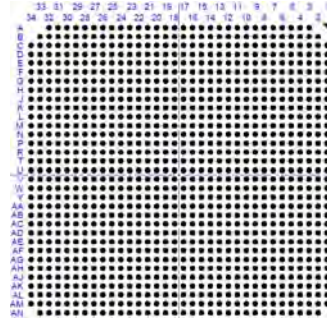

Fig. 6
CCGA1144

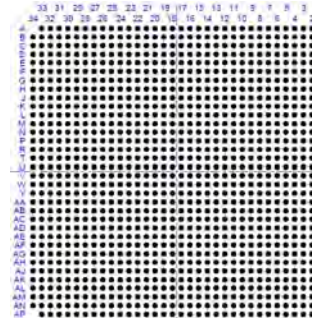

Fig. 7
CCGA1152

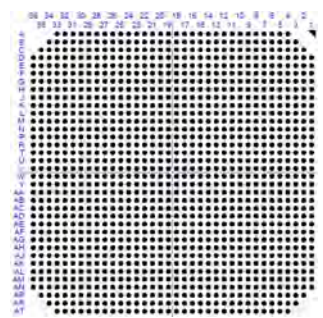

Fig. 8
CCGA1272

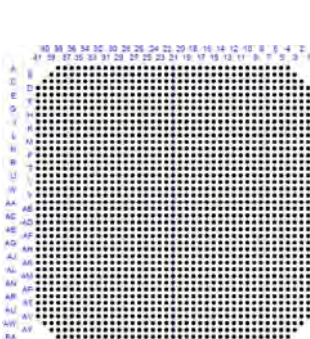

Fig. 9
CCGA1657

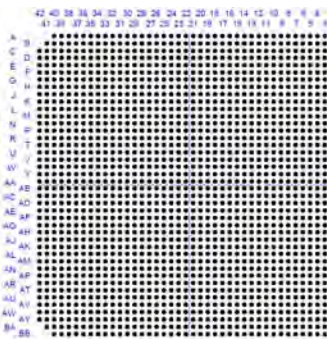
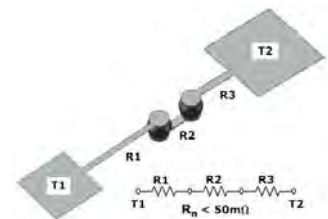

Fig. 10
CCGA1752

ASK FOR
OTHER
PACKAGES
AND PATTERNS



Example
Daisy chain Circuit

About Daisy Chain packages: Daisy Chain is used to detect the onset of failures in the CCGA package. A normal (good) daisy chain circuit has low ohms resistance measured at test points on the PCB board. After the test vehicle PCB board is subjected to harsh conditions, such as vibrating and temperature cycling, an open circuit or significant change in resistance will indicate a failure in the daisy chain circuit. Typical failures are caused by a poor solder joint at the pads or a broken column.

www.CCGA.co/DaisyChain.html

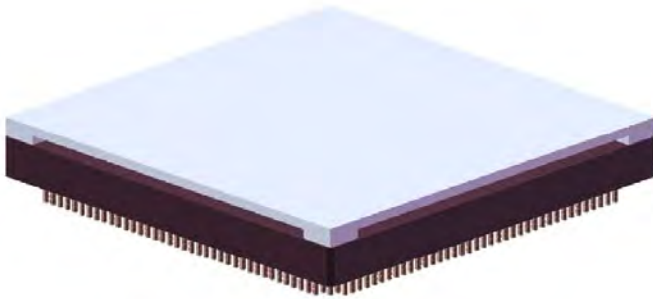

CN Style
Heat Spreader
Corner Posts

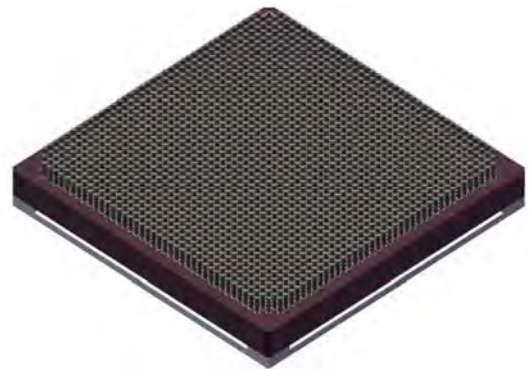

CN Style
Bottom View

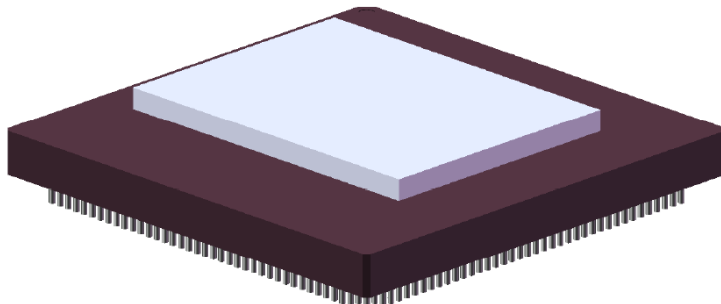

CF Style
Flat Heat Spreader

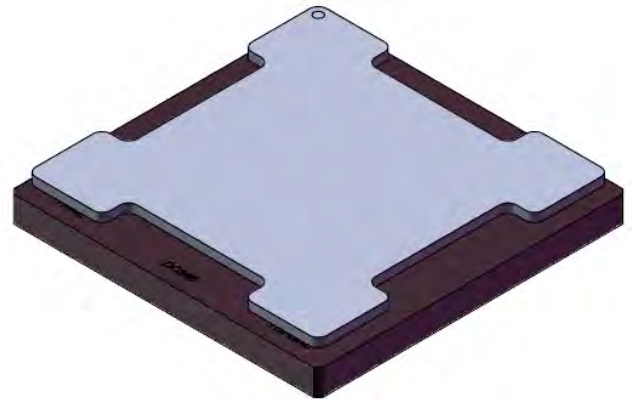

CF4 Style
Top View

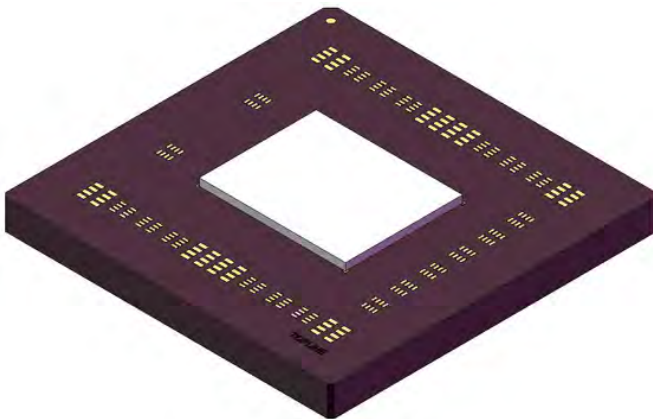

F Style
Surface Mount Die
Shown Without Heat Spreader

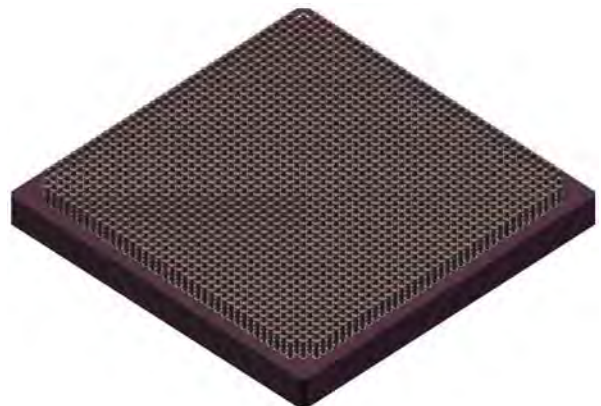

F Style
Bottom View



D Style
Die in Cavity
Under the Lid

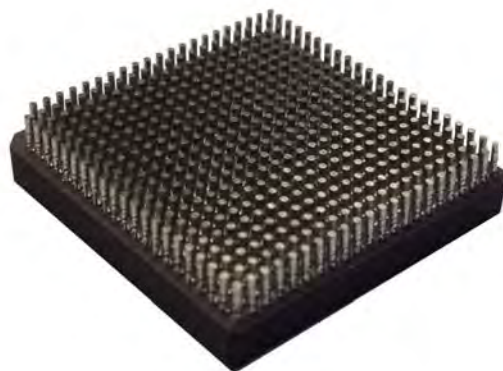

D Style
Bottom View

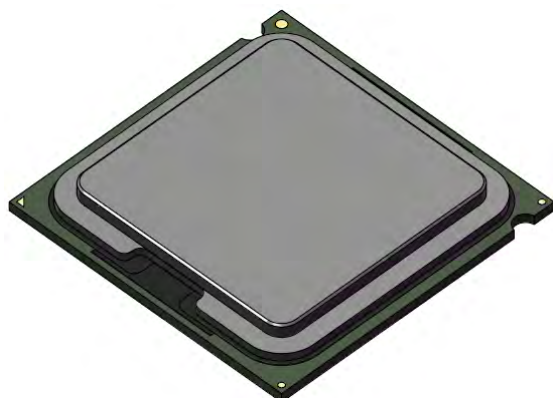

S Style
Plastic LGA Package
Surface Mount Die with Heat Spreader

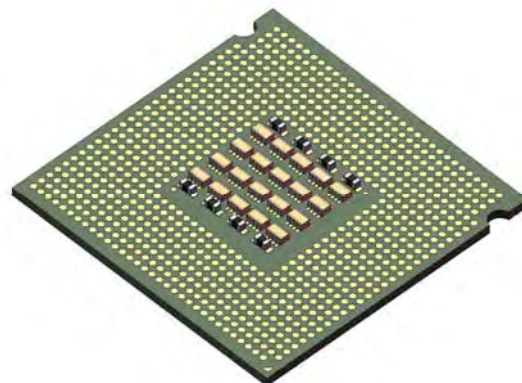

S Style
Plastic Package
Bottom View



CLGA
Without Columns

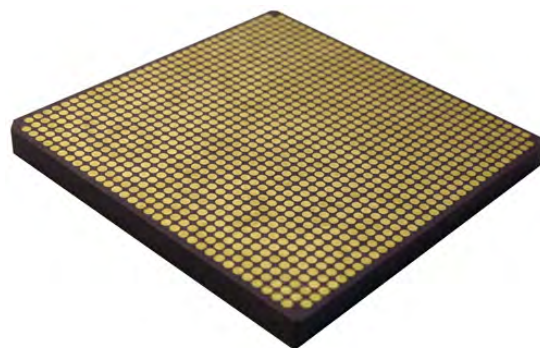

Bottom View
Without Columns

CCGA Size	DWG Nbr	(Z) Max Under Heat Spreader	Attachment	Part Number
-----------	---------	-----------------------------	------------	-------------

Al-SiC Heat Spreader

31 mm	111310	1.95mm	4-Corners	CN-CAP31A
32.5mm	111320	1.95mm	4-Corners	CN-CAP32A
35 mm	111350	1.95mm	4-Corners	CN-CAP35A
37.5mm	111370	1.95mm	4-Corners	CN-CAP37A
40 mm	111400	1.95mm	4-Corners	CN-CAP40A
42.5mm	111420	1.95mm	4-Corners	CN-CAP42A
45 mm	111450	1.95mm	4-Corners	CN-CAP45A
52.5mm	111520	1.95mm	4-Corners	CN-CAP52A

TOP VIEW



UNDER VIEW



After Mounting to Ceramic Substrate

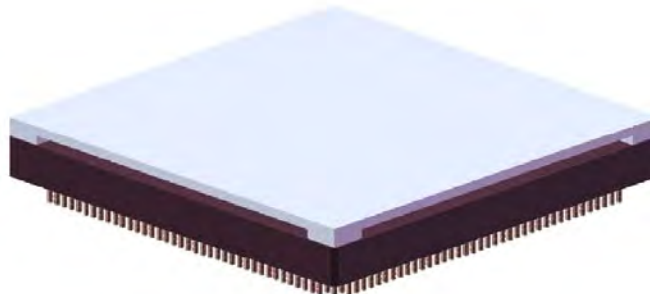

CCGA Part Numbering System

CCGA	1752	T	1.0	A	- DC427	CN
----- Device Type	----- Pins	--- Pack	----- Pitch	----- Column Type	----- Daisy Chain	----- Die Option
<u>CCGA</u> Ceramic Column Grid Array	Nbr of Columns	T= Tray	1.0 = 1.0mm 1.27 = 1.27mm Other pitch Under development	<u>Pb80/Sn20</u> <u>Copper Ribbon</u> Blank = 2.21mm <u>Pb90/Sn10</u> A = Plain (Standard) <u>Micro-coil Spring</u> M = Sn60/Pb40 G = Ni/Au Plated <u>Braided Column</u> B = Copper Braid 16X L = Copper Braid 8X	Drawing Number	D= Die in cavity F=Surface Mount Without Heat Spreader CN= Surface Mount. Pedestal Heat Spreader CF= Surface Mount. Flat Heat Spreader
<u>CLGA</u> Ceramic Land Grid Array						

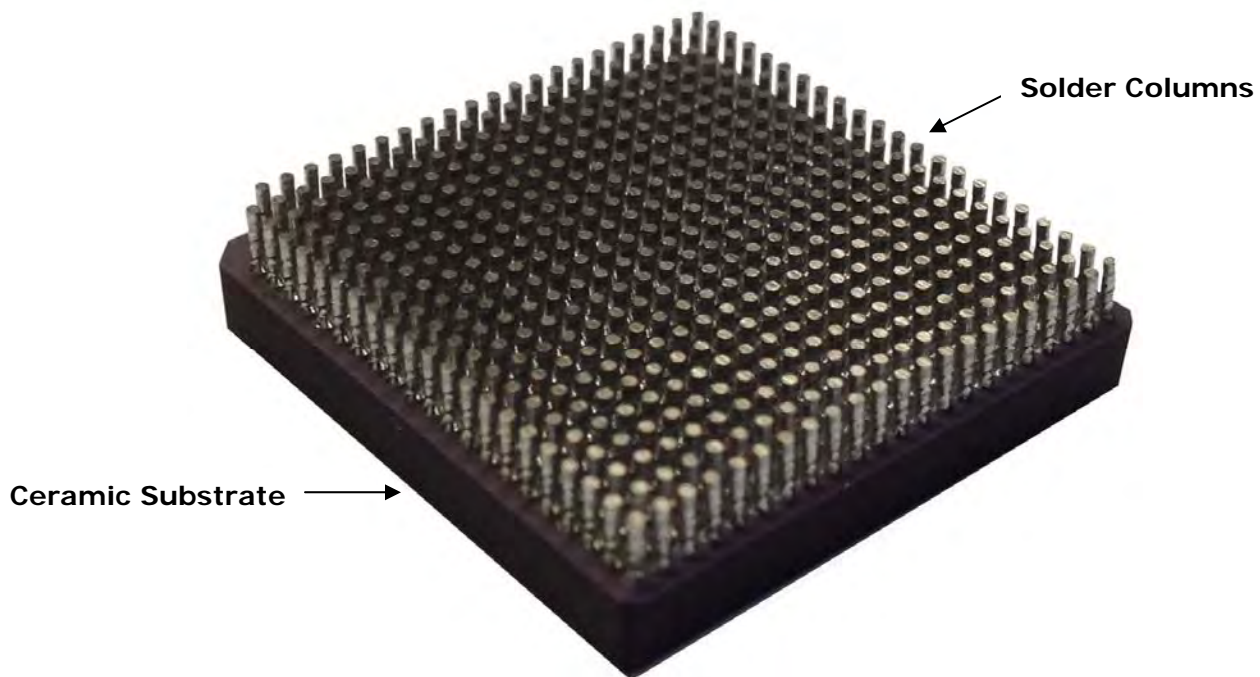

CLGA Daisy Chain Ceramic Test Chip

Pins Nbr	Matrix Array	Pitch	Size	Die	Fig	Part Number	Column Type
Without Columns - Ni Au Pads							
483	22x22	1.0mm	25mm	Inside	1	CLGA483T1.0-DC225D	Without Columns
624	25x25	1.27mm	32.5mm	Inside	2	CLGA624T1.27-DC254D	
717	27x27	1.27mm	35mm	Inside	3	CLGA717T1.27-DC275D	
1140	34x34	1.0mm	35mm	Surface	5	CLGA1140T1.0-DC345D	
1144	34x34	1.0mm	35mm	Surface	6	CLGA1144T1.0-DC348D	
1152	34x34	1.0mm	35mm	Inside	7	CLGA1152T1.0-DC346D	
1272	36x36	1.0mm	37.5mm	Inside	8	CLGA1272T1.0-DC367D	
1657	41x41	1.0mm	42.5mm	Surface	9	CLGA1657T1.0-DC417D	
1752	42x42	1.0mm	45mm	Surface	10	CLGA1752T1.0-DC427CN	

Contact TopLine for other LGA packages.

LGA Part Numbering System

CLGA	1752	T	1.0	-DC427	CN
----- Device Type	----- Pads	----- Pack	----- Pitch	----- Daisy Chain	----- Die Option
CLGA Ceramic Land Grid Array	Nbr of Pads	T=Tray	1.0 = 1.0mm 1.27 = 1.27mm G28 = Ø28mil Pad Plastic LGA Other pitch In Development	Drawing Number	D= Die in cavity. CN= Surface Mount. Pedestal Heat Spreader CF=Surface Mount. Flat Heat Spreader
LGA Plastic Land Grid Array					

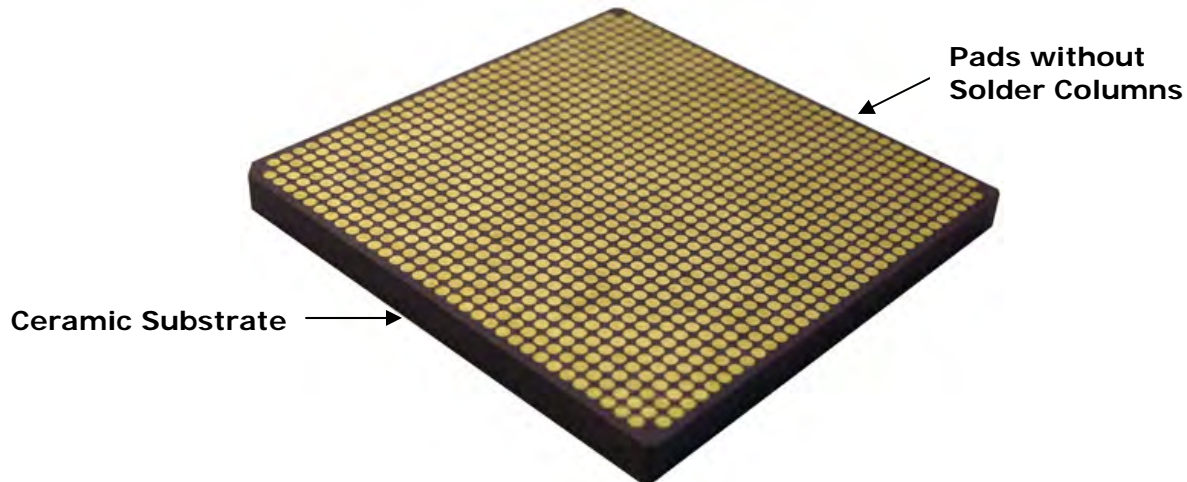

INFO

TopLine supports all ceramic and plastic package styles.

www.CCGA.co/CCGA.html

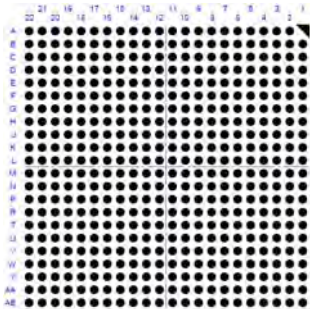

Fig. 1
CCGA483



Fig 2.
CCGA624

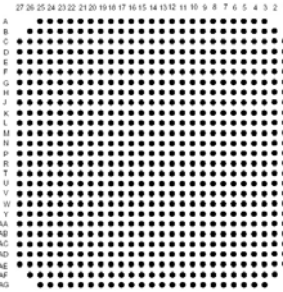

Fig 3.
CCGA717

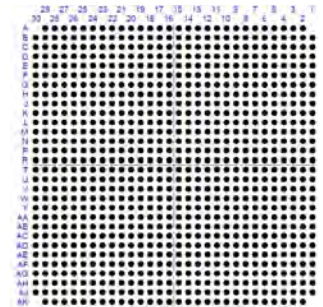

Fig 4.
CCGA896

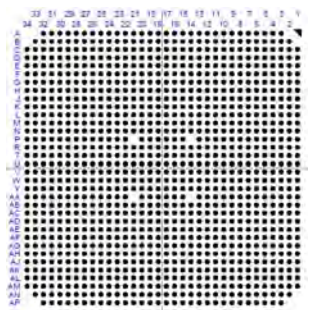

Fig 5
CCGA1140

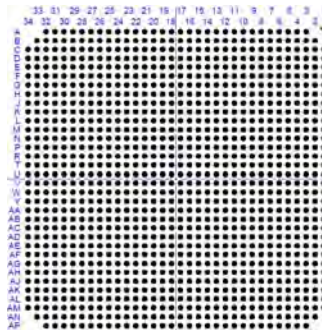

Fig. 6
CCGA1144

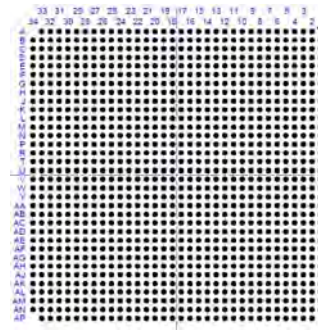

Fig. 7
CCGA1152

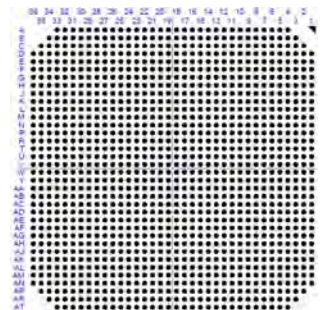

Fig 8
CCGA1272

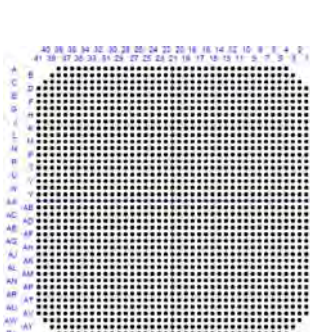

Fig. 9
CCGA1657

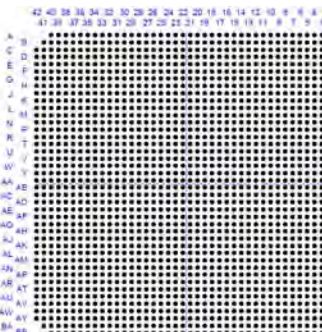
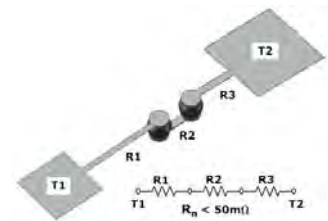

Fig. 10
CCGA1752

ASK FOR
OTHER
PACKAGES
AND PATTERNS



Example
Daisy chain Circuit

About Daisy Chain packages: Daisy Chain is used to detect the onset of failures in the CCGA package. A normal (good) daisy chain circuit has low ohms resistance measured at test points on the PCB board. After mounting the daisy chain CCGA onto a daisy chain test vehicle, the PCB board is subjected to harsh conditions, such as vibrating and temperature cycling. An open circuit or significant change in resistance will indicate a failure in the daisy chain. Typical failures are caused by a poor solder joint at the pads or a broken column.



*Copper
Ribbon*

Pb80/Sn20 (Standard)
Pb90/Sn10 (New)
Copper Wrap Column
Coated with Sn63/Pb37



**Invented
by
NASA**

Micro-coil Spring
Be-Cu
RoHS Ni-Au or Sn60/Pb40



*Original
Version*

Pb90/Sn10
Plain Solder Wire
Original Version



RoHS

Lead Free Copper Braided Column
Better than Copper Wrap



RoHS

Lead Free Gold
Pure Au 4N



New
US Patent
10,477,698

Copper Braided Column
Better than Copper Wrap



Column Numbering System

Telephone:
+1-800-776-9888

Column Part Numbering System

CG	8020	C	20	X	91
-----	-----	----	-----	---	-----
Column Type	Alloy	Plating	Ø Dia Mils	Pack	Length Mil
CG Solder Column	8020 Pb80/Sn20	C = Copper Wrap + Sn63/Pb37 U = Unplated (without copper) B = Copper Braided (16x) L = Copper Braided (8x)	5 = 0.13mm 6 = 0.15mm 7 = 0.18mm 8 = 0.20mm 9 = 0.22mm 10 = 0.25mm 11 = 0.28mm 12 = 0.30mm 13 = 0.33mm 14 = 0.35mm 15 = 0.38mm 16 = 0.40mm 18 = 0.45mm 20 = 0.51mm 22 = 0.56mm 35 = 0.89mm Other Available	X = Jar Standard E = Tape & Reel	<u>Solder Column</u> 20 = 0.50mm 31 = 0.80mm 40 = 1.00mm 50 = 1.27mm 60 = 1.52mm 70 = 1.78mm 87 = 2.21mm 91 = 2.31mm 93 = 2.36mm 95 = 2.41mm 97 = 3.81mm 100 = 2.54mm 145 = 3.70mm 150 = 3.81mm
MCS Micro-Coil Spring	9010 Pb90/Sn10	H = RoHS Copper Braided (16x) J = RoHS Copper Braided (8x)			
CU Copper Pillar	172 Micro-coil Spring	Micro-coil Spring P = Plated Sn60/Pb40 G = Plated Ni/Au			
BC Braided Copper	101 OFHC CDA101	Solid Copper P = Plated Sn60/Pb40 F = Plated NiPdAu (RoHS)			
CC Copper Core	110 Copper Alloy	Solid Gold N = Pure Gold 4N			<u>Micro Coil Spring</u> 40 = 1.00mm 50 = 1.27mm

Note: See page 26~27 for trimming column length after reflow

Column Order#

8	20	91	3
-----	-----	----	-----
Column Type	Ø Dia Mils	Length Mil	Package Qty
Pb80/Sn20 8 = Cu Wrap Ribbon (Standard) Coated Sn63/Pb37 (C)	05 = 0.13mm 06 = 0.15mm 08 = 0.20mm 09 = 0.23mm 10 = 0.25mm 11 = 0.28mm 12 = 0.30mm 13 = 0.33mm 14 = 0.35mm 15 = 0.38mm 16 = 0.40mm 18 = 0.45mm 20 = 0.50mm 22 = 0.56mm 35 = 0.89mm	Mil - mm 20 = 0.50mm 25 = 0.63mm 31 = 0.80mm 40 = 1.00mm 50 = 1.27mm 60 = 1.52mm 70 = 1.78mm 87 = 2.21mm 91 = 2.31mm 99 = 2.54mm 96 = 3.70mm 97 = 3.81mm Other Available	<u>Code • Qty</u> 0 = 100pcs 1 = 1Kpcs 2 = 5Kpcs 3 = 10Kpcs 7 = Reel 2500 8 = Tray 9 = Bulk
Pb90/Sn10 9 = Plain Column (U) 0 = Copper Wrap Ribbon (C)			
Micro-Coil Spring: 1 = Be-Cu C17200 Sn60/Pb40 (P) 2 = Be-Cu C17200 Ni/Au (G)			
Cu Pillar 3 = CDA101 Sn60/Pb40 Plating (P) 4 = CDA101 Unplated (U) RoHS 6 = CDA101 Ni Au Plating (G) RoHS			
Copper Braided 7 = Braided Columns (B) Sn63/Pb37			

Column Diameter	*Column Length	Core	Copper Ribbon Thick	Outer Plating	Column Part Number	Column Type
-----------------	----------------	------	---------------------	---------------	--------------------	-------------

Pb80/Sn20 Column - Copper Wrap

Ø 0.30mm (12 mil)	1.52mm (60 mil)	Ø 0.25mm (10 mil)	25µm (1.0 mil)	Sn63/Pb37 Solder Coated	CG8020C12x60	 <p>Column Pb80/Sn20 Copper Wrap</p>
	2.21mm (87 mil)				CG8020C12x87	
	2.31mm (91 mil)				CG8020C12x91	
Ø 0.38mm (15 mil)	2.21mm (87 mil)	Ø 0.30mm (12 mil)	25µm (1.0 mil)	Sn63/Pb37 Solder Coated	CG8020C15x87	
	2.31mm (91 mil)				CG8020C15x91	
Ø 0.51mm (20 mil)	2.21mm (87 mil)	Ø 0.38mm (15 mil)	38µm (1.5mil)	Sn63/Pb37 Solder Coated	CG8020C20x87	
	2.31mm (91 mil)				CG8020C20x91	
	2.54mm (100 mil)				CG8020C20x100	
	3.81mm (0150mil)				CG8020C20x150	
Ø 0.56mm (22 mil)	2.21mm (0.087")	Ø 0.45mm (18 mil)	38µm (1.5 mil)	Sn63/Pb37 Solder Coated	CG8020C22x87	
	2.31mm (0.091")				CG8020C22x91	

*Please ask about other Diameters and Lengths Available

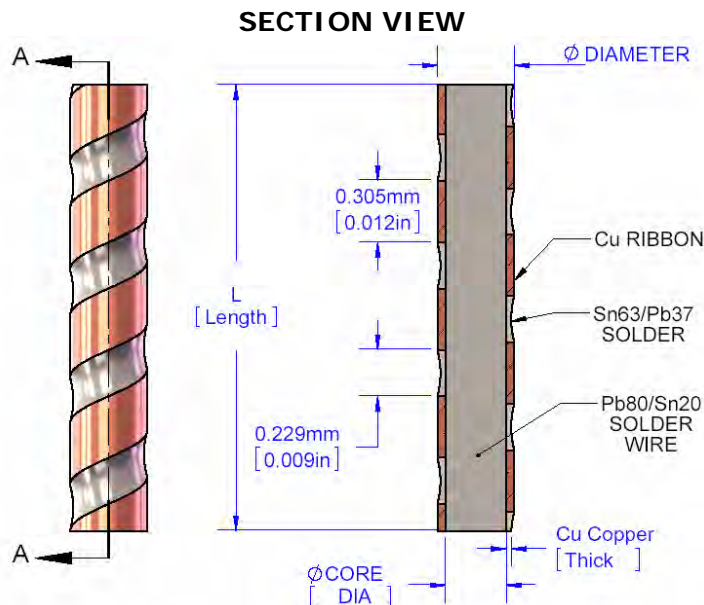

INFO

*Columns must be trimmed, lapped (polished) to the desired final length (example 2.21mm) after reflow. See page 26~27 for trimming column length after reflow to substrates.

www.CCGA.co/CCGA_Column.html

Solder Columns Pb90/Sn10 Plain Column



Column Diameter	*Column Length	Core	Copper Ribbon	Outer Plating	Column Part Number	Column Type
-----------------	----------------	------	---------------	---------------	--------------------	-------------

Pb90/Sn10 - Plain Column

Ø 0.20mm (8 mil)	1.27mm (0.050")	Pb90/Sn10	None	None	CG9010U8x50	<p>Column Pb90/Sn10 Plain Column</p>
Ø 0.25mm (10 mil)	1.52mm (0.060")	Pb90/Sn10	None	None	CG9010U10x60	
Ø 0.30mm (12 mil)	2.21mm (0.087")	Pb90/Sn10	None	None	CG9010U12x87	
	2.31mm (0.091")				CG9010U12x91	
Ø 0.38mm (15 mil)	2.21mm (0.087")	Pb90/Sn10	None	None	CG9010U15x87	
	2.31mm (0.091")				CG9010U15x91	
Ø 0.50mm (20 mil)	2.21mm (0.087")	Pb90/Sn10	None	None	CG9010U20x87	
	2.31mm (0.091")				CG9010U20x91	
	2.54mm (0.100")				CG9010U20x100	
Ø 0.56mm (22 mil)	2.21mm (0.087")	Pb90/Sn10	None	None	CG9010U22x87	
	2.31mm (0.091")				CG9010U22x91	
	2.54mm (0.100")				CG9010U22x100	

*Please ask about other Diameters and Lengths Available

INFO

*Columns must be trimmed, lapped (polished) to the desired final length (example 2.21mm) after reflow. See page 26-27 for trimming column length after reflow to substrates.

www.CCGA.co/CCGA_Column.html



Column Diameter	Column Length	Copper Core	Plating Thick (Th)	Outer Plating	Column Part Number	Column Type
-----------------	---------------	-------------	--------------------	---------------	--------------------	-------------

CDA101-OFE Pure 4N Column – Au Gold Plated

Ø 0.127mm (5 mil)	1.00mm (50 mil)	Ø 0.127mm (5mil)	0.127 µm (5 micro-inch)	Au	CU101G5x40	<p>Copper Column CDA101 Au Plated</p>
	1.27mm (50 mil)				CU101G5x50	
Ø 0.15mm (6 mil)	1.00mm (40mil)	Ø 0.15mm (6mil)	0.127 µm (5 micro-inch)	Au	CU101G6x40	
	1.27mm (50mil)				CU101G6x50	
Ø 0.20mm (8 mil)	1.00mm (40 mil)	Ø 0.20mm (8mil)	0.127 µm (5 micro-inch)	Au	CU101G8x40	
	1.27mm (50 mil)				CU101G8x50	
Ø 0.25mm (10 mil)	1.00mm (40 mil)	Ø 0.25mm (10mil)	0.127 µm (5 micro-inch)	Au	CU101G10x40	
	1.27mm (50 mil)				CU101G10x50	
	2.21mm (87 mil)				CU101G10x87	
Ø 0.30mm (12 mil)	1.00mm (40 mil)	Ø 0.30mm (12mil)	0.127 µm (5 micro-inch)	Au	CU101G12x40	
	1.27mm (50 mil)				CU101G12x50	
Ø 0.35mm (14 mil)	1.27mm (50 mil)	Ø 0.35mm (14mil)	0.127 µm (5 micro-inch)	Au	CU101G14x50	
	2.21mm (87 mil)				CU101G14x87	
Ø 0.38mm (15 mil)	1.50mm 63 mil)	Ø 0.40mm (16mil)	0.127 µm (5 micro-inch)	Au	CU101G15x63	
	2.21mm (87 mil)				CU101G15x87	
Ø 0.40mm (16 mil)	1.50mm 63 mil)	Ø 0.40mm (16mil)	0.127 µm (5 micro-inch)	Au	CU101G16x63	
	2.21mm (87 mil)				CU101G16x87	
Ø 0.40mm (16 mil)	1.50mm 63 mil)	Ø 0.40mm (16mil)	0.127 µm (5 micro-inch)	Au	CU101G16x63	
	2.21mm (87 mil)				CU101G16x87	

INFO

Copper core OFE Oxygen Free CDA101 provides low thermal resistance than solder columns. Improved conduction of heat to the PCB. Shorter copper path from end-to-end of the column, instead of longer copper wrapped helix. The exterior wall are smooth. The exterior is solder coated with Au Gold. Other Lengths available. Also available new RoHS Cu with NiAu plating.

www.CCGA.co/CCGA_Column.html

Solder Columns Pb90/Sn10 Cu Copper Wrap Wider Reflow Process Window



Column Diameter	*Column Length	Core	Copper Thick (T)	Outer Plating	Column Part Number	Column Type
-----------------	----------------	------	------------------	---------------	--------------------	-------------

Pb90/Sn10 Column - Copper Wrap

Ø 0.25mm (10mil)	1.27mm (50 mil)	Ø 0.20mm (0.008")	25um (1.0 mil)	Sn63/Pb37 Hot Solder	CG9010C10x50	 <p>Column Pb90/Sn10 Copper Wrap</p>
	1.52mm (60 mil)				CG9010C10x60	
Ø 0.30mm (12mil)	2.21mm (87 mil)	Ø 0.25mm (0.010")	25um (1.0 mil)	Sn63/Pb37 Hot Solder	CG9010C12x63	
	2.31mm (91 mil)				CG9010C12x75	
Ø 0.38mm (15mil)	2.21mm (87 mil)	Ø 0.30mm (12mil)	25um (1.0 mil)	Sn63/Pb37 Hot Solder	CG9010C15x87	
	2.31mm (91 mil)				CG9010C15x91	
Ø 0.51mm (20mil)	2.21mm (87 mil)	Ø 0.40mm (16mil)	38um (1.5 mil)	Sn63/Pb37 Hot Solder	CG9010C20x87	
	2.31mm (91 mil)				CG9010C20x91	
	2.54mm (100 mil)				CG9010C20x100	
	3.81mm (150 mil)				CG9010C20x150	

*Please ask about other Diameters and Lengths Available

SECTION VIEW

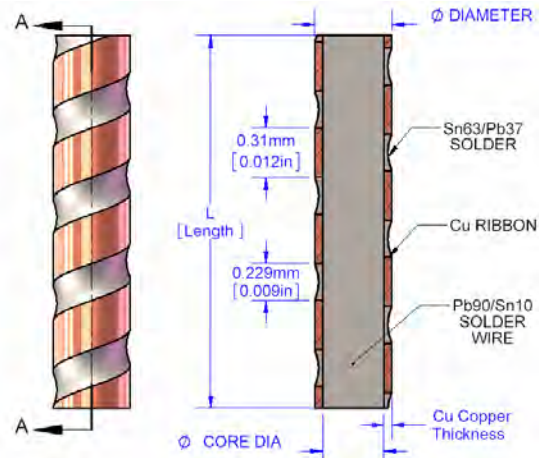

INFO

New Pb90/Sn10 with Cu Wrap provides wider process window for secondary reflow to PCB.

*Columns must be trimmed, lapped (polished) to the desired final length (example 2.21mm) after reflow. See page 26~27 for trimming column length after reflow to substrates.

www.CCGA.co/CCGA_Column.html



Spring Diameter	* Free Length	Wire Size	PCB Land Minimum	Outer Plating	Column Part Number	Column Type
-----------------	---------------	-----------	------------------	---------------	--------------------	-------------

Micro Coil Spring

Ø 0.40mm (0.016")	1.0 mm (0.040")	Ø 63 µm (0.00245")	Ø 0.50 mm (0.020")	Sn60/Pb40 Electroplated Tin-Lead	MCS172P16x40	 Micro-Coil Spring Be-Cu
				Ni/Au RoHS Pb-Free	MCS172G16x40	
Ø 0.50mm (0.020")	1.27 mm (0.050")	Ø 86 µm (0.0034")	Ø 0.70 mm (0.020")	Sn60/Pb40 Electroplated Tin-Lead	MCS172P20x50	
				Ni/Au RoHS Pb-Free	MCS172G20x50	

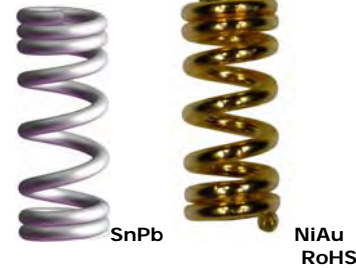

Example Outline Drawing

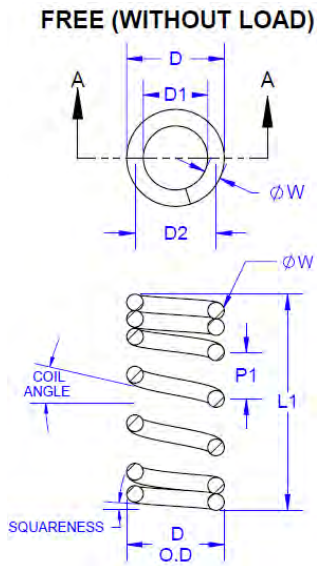

DIMENSIONS FREE WITHOUT LOAD (mm)								
Part#	ØD O.D.	L1	ØD Wire	P1	Active Coils	Total Coils	ØD1 I.D.	Coil Deg.
MCS172P16x40 MCS172G16x40	0.406	1.02	0.063	0.15	4.8	8.8	0.282	7.74°
MCS172P20x50 MCS172G20x50	0.500	1.27	0.086	0.25	3.3	7.3	0.335	10.85°

NOTES:

- MATERIAL: BERYLLIUM COPPER (Be-Cu) - C17200 (ALLOY 25)
- TEMPER: HARD TEMPER (TD05) PER ASTM B 197
- COIL: CYLINDRICAL DOUBLE-CLOSED END - SQUARED (CENG)
- PLATED: Sn60/Pb40 - 100 Micro-inch (min) over Ni 50 Micro-Inch (min)
Gold Plating: Ni 30~60micro-inch and Au 10micro-inch

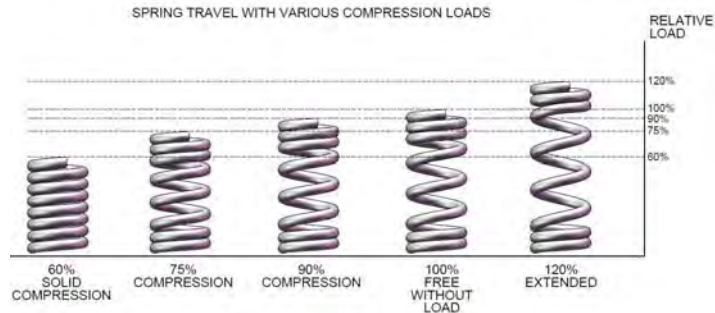
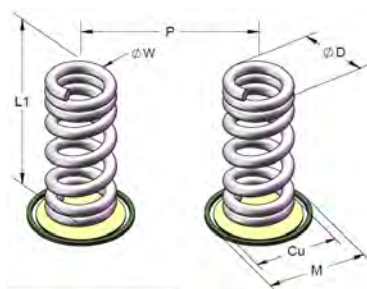

INFO

*Length without compression load.

Micro-coil springs do not require trimming or lapping.

www.topline.co/CCGA_MCS_Micro_Coil_Spring.html

Micro-Coil Springs - CCGA 1152

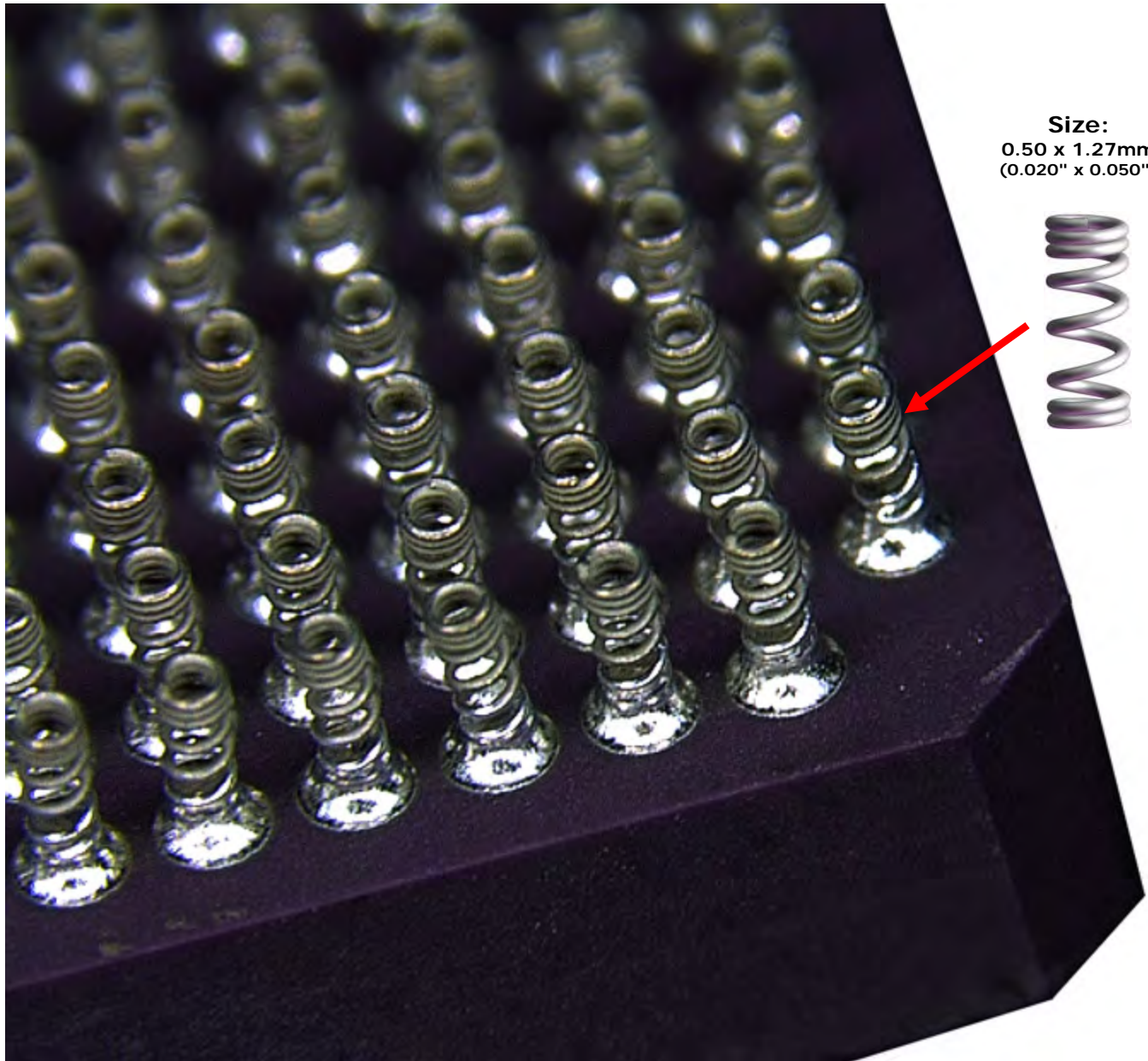

Cu Braided Solder Columns Pb80/Sn20

Cu Copper Braided
Better Thermal Characteristics



Column Diameter	*Column Length	Core	Copper Thick (T)	Outer Plating	Column Part Number	Column Type
-----------------	----------------	------	------------------	---------------	--------------------	-------------

Pb90/Sn10 Column - Copper Braid

Ø 0.30mm (12mil)	1.52mm (60 mil)	Ø 0.20mm (0.008")	25um (1.0 mil)	Sn63/Pb37 Hot Solder	BC8020B12x60	 Column Pb90/Cu Braid
	2.21mm (87 mil)				BC8020B12x87	
Ø 0.35mm (14mil)	2.21mm (87 mil)	Ø 0.20mm (0.008")	38um (1.5 mil)	Sn63/Pb37 Hot Solder	BC8020B14x87	
	2.36mm (913)				BC8020B14x93	
Ø 0.40mm (16mil)	2.21mm (87 mil)	Ø 0.25mm (10mil)	38um (1.5 mil)	Sn63/Pb37 Hot Solder	BC8020B15x87	
	2.36mm (93 mil)				BC8020B15x93	
Ø 0.51mm (20mil)	2.21mm (87 mil)	Ø 0.35mm (14mil)	38um (1.5 mil)	Sn63/Pb37 Hot Solder	BC8020B20x87	
	2.36mm (93 mil)				BC8020B20x93	
	2.54mm (100 mil)				BC8020B20x100	

*Please ask about other Diameters and Lengths Available

SECTION VIEW

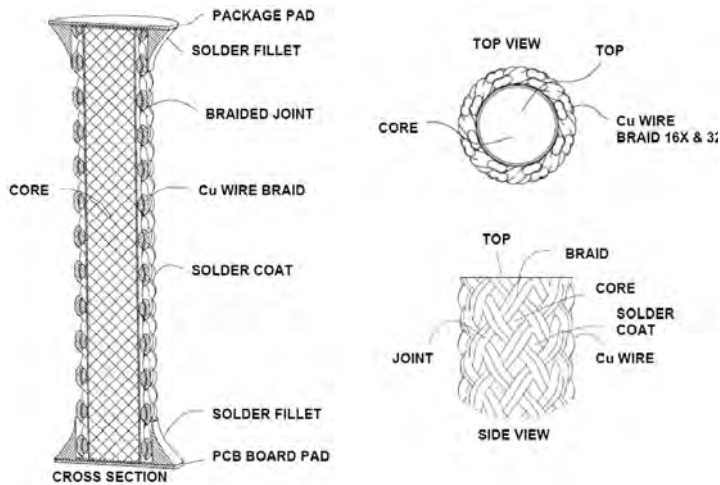

DETAIL VIEW

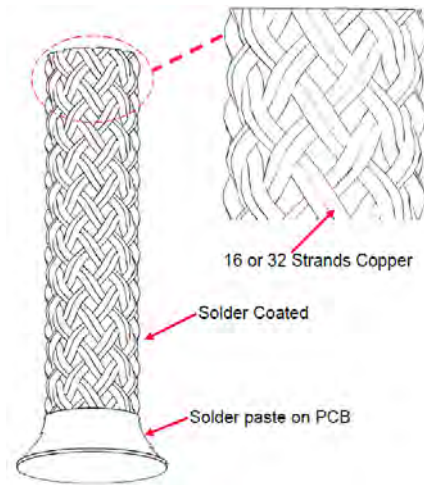

INFO

New Cu Braided provides non-collapsible columns. Shorter signal and thermal path to PCB.

*Columns must be trimmed, lapped (polished) to the desired final length (example 2.21mm) after reflow. See page 26~27 for trimming column length after reflow to substrates.

www.CCGA.co/CCGA_Column.html

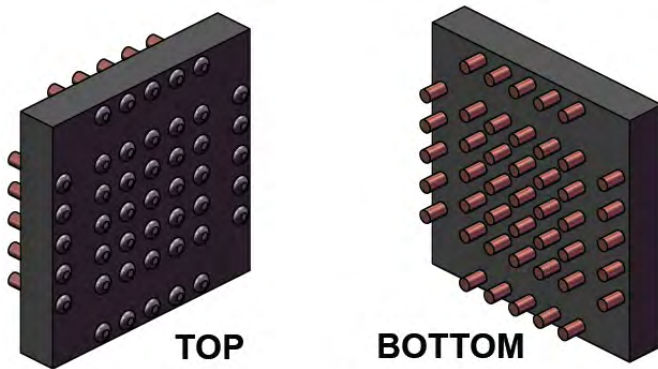

Solderable Column Interposers

Solderable interposers (Package on Package) with compliant columns to absorb CTE mismatch between the LGA and the PCB. Tin/Lead and Lead-Free available. Braided Columns, Copper Columns or Micro-Coil Springs to match specific applications.

Features:

- LGA package size: Up to 100x100mm
- Pitch: 0.5mm to 1.27mm
- Pack on Package mounting
- Choice of column type
- Absorbs CTE mismatch

Exploded View of Socket

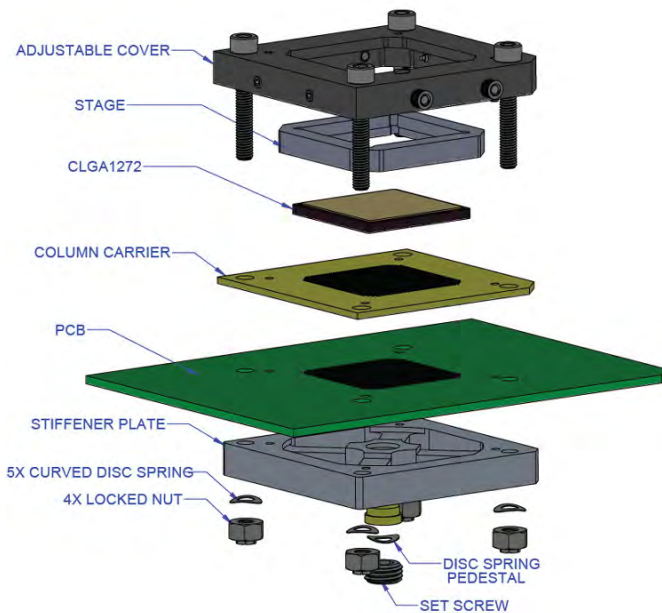

Compression Socket Interposers

Features:

- Ceramic CLGA package size: Up to 57x57mm
- Pitch: 1.0mm and 1.27mm and others
- Novel Spring locks absorb CTE mismatch
- Applies equal force from center to perimeter
- Open top frame allows heat-sink mounting
- Clearance in bottom stiffener for capacitors
- Set Includes precision alignment template

Example of Carrier with exposed column bumps

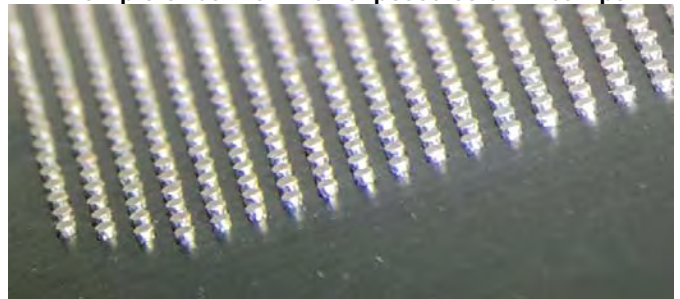

Flip-Pack® Filled Cassette With Solder columns

US Patent 9,629,259



Pins Nbr	Matrix Array	Pitch	CCGA Size	Ø Dia Column	*Column Length Before Trimming	Pin-Pack Part Number	Column Type
----------	--------------	-------	-----------	--------------	--------------------------------	----------------------	-------------

Pb80/Sn20 Column - Copper Wrap

483	22x22	1.0mm	23mm	0.51mm	2.31mm	FP83C483E20x91A	<p>Column Pb80/Sn20 Copper Wrap</p>
624	25x25	1.27mm	32.5mm	0.51mm	2.31mm	FP83C624F20x91A	
717	27x27	1.27mm	35mm	0.51mm	2.31mm	FP83C717F20x91A	
896	30x30	1.0mm	31mm	0.51mm	2.31mm	FP83C896E20x91A	
1140	34x34	1.0mm	35mm	0.51mm	2.31mm	FP83C1140E20x91A	
1144	34x34	1.0mm	35mm	0.51mm	2.31mm	FP83C1144E20x91A	
1152	34x34	1.0mm	35mm	0.51mm	2.31mm	FP83C1152E20x91A	
1272	36x36	1.0mm	37.5mm	0.51mm	2.31mm	FP83C1272E20x91A	
1657	41x41	1.0mm	42.5mm	0.51mm	2.31mm	FP83C1657E20x91A	
1752	42x42	1.0mm	45mm	0.51mm	2.31mm	FP83C1752E20x91A	

Pb90/Sn10 - Plain Column

483	22x22	1.0mm	23mm	0.50mm	2.31mm	FP90U483E20x91A	<p>Column Pb90/Sn10 Plain</p>
624	25x25	1.27mm	32.5mm	0.50mm	2.31mm	FP90U624F20x91A	
717	27x27	1.27mm	35mm	0.50mm	2.31mm	FP90U717F20x91A	
896	30x30	1.0mm	31mm	0.50mm	2.31mm	FP90U896E20x91A	
1140	34x34	1.0mm	35mm	0.50mm	2.31mm	FP90U1140E20x91A	
1144	34x34	1.0mm	35mm	0.50mm	2.31mm	FP90U1144E20x91A	
1152	34x34	1.0mm	35mm	0.50mm	2.31mm	FP90U1152E20x91A	
1272	36x36	1.0mm	37.5mm	0.50mm	2.31mm	FP90U1272E20x91A	
1657	41x41	1.0mm	42.5mm	0.50mm	2.31mm	FP90U1657E20x91A	
1752	42x42	1.0mm	45mm	0.50mm	2.31mm	FP90U1752E20x91A	

Micro Coil Spring

483	22x22	1.0mm	23mm	0.50mm	1.27mm	FP17U483E20x50A	<p>Micro-Coil Spring Invented by NASA Be-Cu</p>
624	25x25	1.27mm	32.5mm	0.50mm	1.27mm	FP17P624F20x50A	
717	27x27	1.27mm	35mm	0.50mm	1.27mm	FP17P717F20x50A	
896	30x30	1.0mm	31mm	0.50mm	1.27mm	FP17P896E20x50A	
1140	34x34	1.0mm	35mm	0.50mm	1.27mm	FP17P1140E20x50A	
1144	34x34	1.0mm	35mm	0.50mm	1.27mm	FP17P1144E20x50A	
1152	34x34	1.0mm	35mm	0.50mm	1.27mm	FP17P1152E20x50A	
1272	36x36	1.0mm	37.5mm	0.50mm	1.27mm	FP17P1272E20x50A	
1657	41x41	1.0mm	42.5mm	0.50mm	1.27mm	FP17P1657E20x50A	
1752	42x42	1.0mm	45mm	0.50mm	1.27mm	FP17P1752E20x50A	

Flip-Pack are cassettes pre-loaded with solder columns that match the matrix of the LGA package. Columns are held inside the Flip-Pack. Remove the covers to empty the columns into the graphite fixture. The columns will fall into the C7-GRAPHITE fixture by gravity without vibration or vacuum. The empty Flip-Pack can be re-filled or used as a tray carrier to protect the CCGA columns during storage or transport.

*Columns must be trimmed, lapped (polished) to the desired final length (example 2.21mm) after reflow. See page 26~27 for trimming column length after reflow to substrates. Micro-coils do not require trimming.

www.CCGA.co/CCGA_PinPack.html

Flip-Pack® Numbering System

US Patents 9,629,259 and 9,108,262



Flip-Pack Part Numbering System

FP	8	3	C	1152	E	20	x	93	A
Series	Alloy	Style	Plating	Nbr Pin	Pitch	Ø Dia Mils		Length Mils	Rev
FP = Filled FLIP-PACK With Columns	<u>Code</u> • <u>Desc</u> 8 • Pb80/Sn20	<u>Code</u> • <u>Desc</u> 3 • Cu Wrap	<u>Code</u> • <u>Desc</u> C • Sn63/Pb37	<u>Code</u> • <u>Matrix</u> 483 = 22x22 484 = 22x22 624 = 25x25 717 = 27x27 896 = 30x30 1140 = 34x34 1144 = 34x34 1148 = 34x34	<u>Code</u> • <u>Pitch</u> E • 1.0mm F • 1.27mm	<u>Code</u> • <u>Metric</u> 5 • 0.127mm 6 • 0.150mm 8 • 0.200mm 10 • 0.250mm 12 • 0.300mm 15 • 0.380mm 16 • 0.400mm 18 • 0.450mm 20 • 0.500mm 22 • 0.560mm		<u>Code</u> • <u>MM</u> 40 • 1.00mm 50 • 1.27mm 60 • 1.52mm 87 • 2.21mm 91 • 2.31mm 93 • 2.36mm 100 • 2.54mm 150 • 3.81mm	<u>Rev</u> A-Z
FS = Empty Set FLIP-PACK Without Columns	6 • Cu Pillar 3 • Cu Pillar 4 • Cu Pillar	7 • Micro Coil SnPb Plated 9 • Micro Coil Gold Plated	G • Ni/Au Gold Micro-Coil F • NiPdAu U • Unplated	1152 = 34x34 1272 = 36x36 1509 = 40x40 1657 = 41x41 1752 = 42x42 2577 = 51x51	Y 1.17/1.09mm Z • Other				*See note Column trimming

Flip-Pack Order#

8	3	1	34	0
Column Alloy	Style	Pitch	Array	Version
<u>Code</u> • <u>Description</u> 8 = Pb80/Sn20 9 = Pb90/Sn10 5 = Pb85/Sn15 1 = Micro-Coil 3 = Cu Column 0 = Empty FLIP-PACK	<u>Code</u> • <u>Description</u> 0 = Plain Wire 3 = Copper Wrap 4 = Electro Plated 7 = Micro-coil Spring SnPb 9 = Micro-coil Spring NiAu	<u>Code</u> • <u>Pitch</u> 1 = 1.0mm 2 = 1.27mm 4 = 0.4mm 5 = 0.5mm 6 = 0.65mm 8 = 0.8mm 9 = Other	<u>Code</u> • <u>Matrix</u> 22 = 22x22 25 = 25x25 26 = 26x26 26 = 27x27 30 = 30x30 34 = 34x34 36 = 36x36 42 = 42x42	Solder Column: <u>Code</u> • <u>Version</u> 0 = Rev A 1 = Rev B 2 = Rev C 3 = Rev D Etc.

Cross Section of Typical Flip-Pack™

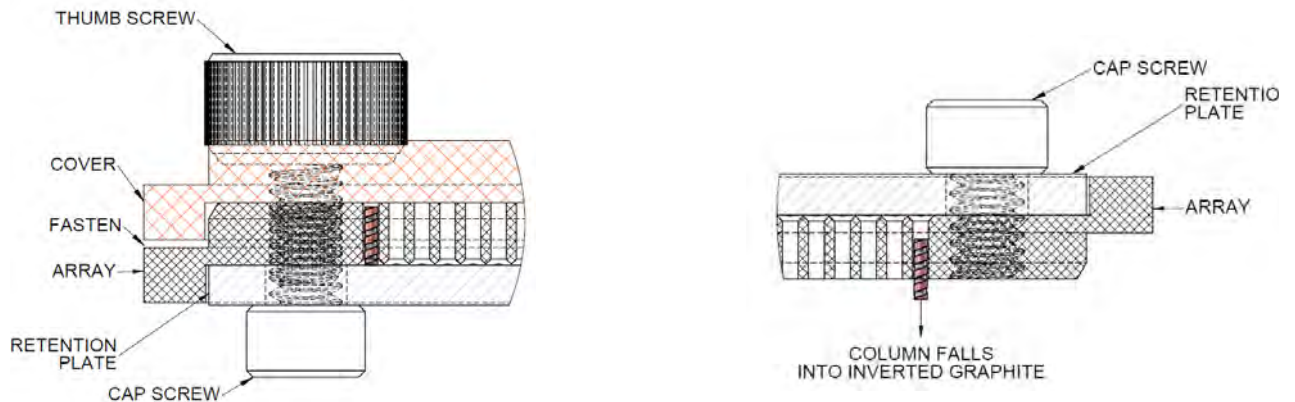

*Columns must be trimmed, lapped (polished) to the desired final length (example 2.21mm) after reflow. See page 26~27 for trimming column length after reflow to substrates. Micro-coil Springs do not require trimming.



Graphite Tool-Set Column Attachment

US Patents D808350, D874413, D908648



Model Number	Column Type	Substrate X/Y Size	Thickness	Matrix Array	Pitch	Column Ø Dia	Device Type
C7-GRAPHITE-483-A	Column	23x23mm	3.2mm	22x22	1.0mm	Ø0.51mm	CG483
C7-GRAPHITE-624-A	Column	32.5x32.5mm	2.8mm	25x25	1.27mm	Ø0.51mm	CG624
C7-GRAPHITE-624-M	Micro-Coil	32.5x32.5mm	2.8mm	25x25	1.27mm	Ø0.51mm	CG624
C7-GRAPHITE-672-A	Column	35x35mm	5.2mm	26x26	1.27mm	Ø0.51mm	3121.431433.013
C7-GRAPHITE-717-A	Column	35x35mm	-	27x27	1.27mm	Ø0.51mm	CG717
C7-GRAPHITE-771-A	Column	37.5x37.5mm	4.0mm	30x33	1.17/1.09	Ø0.51mm	WCGA771
C7-GRAPHITE-898-A	Column	31x31mm	-	30x30	1.0mm	Ø0.51mm	CG898
C7-GRAPHITE-1140-A	Column	35x35mm	-	34x34	1.0mm	Ø0.51mm	CG1140
C7-GRAPHITE-1144-A	Column	35x35mm	-	34x34	1.0mm	Ø0.51mm	CG1144
C7-GRAPHITE-1152-A	Column	35x35mm	3.2mm	34x34	1.0mm	Ø0.51mm	CG1152
C7-GRAPHITE-1152-B	Column	35x35mm	2.1mm	34x34	1.0mm	Ø0.38mm	FC1152 Plastic
C7-GRAPHITE-1152-M	Micro-Coil	35x35mm	3.2mm	34x34	1.0mm	Ø0.50mm	CG1152
C7-GRAPHITE-1152-MC	Micro-Coil	35x35mm	2.1mm	34x34	1.0mm	Ø0.40mm	FC1152 Plastic
C7-GRAPHITE-1272-A	Column	37.5x37.5mm	3.3mm	36x36	1.0mm	Ø0.51mm	CG1272
C7-GRAPHITE-1657-A	Column	42.5x42.5mm	2.54mm	41x41	1.0mm	Ø0.51mm	CG1657
C7-GRAPHITE-1657-M	Micro-Coil	42.5x42.5mm	2.54mm	41x41	1.0mm	Ø0.51mm	CG1657
C7-GRAPHITE-1752-A	Column	45x45mm	4.1mm	42x42	1.0mm	Ø0.51mm	CG1752
C7-GRAPHITE-1752-CN	Column	45x45mm	6.0mm	42x42	1.0mm	Ø0.51mm	CN1752
C7-GRAPHITE-1752-CF	Column	45x45mm	7.0mm	42x42	1.0mm	Ø0.51mm	CF1752
C7-GRAPHITE-1752-44	Column	57x57mm	4.1mm	44x44	1.27mm	Ø0.51mm	301176.254

Contact TopLine for other graphite tools.

FEATURES

- Custom fabricated to match LGA package dimensions.
- Graphite Tool-set includes: Bottom base graphite, top graphite and positioning pegs
- Solder Columns: Sold separately.
- Flip-Pack™ pre-loaded cassettes with columns - Sold separately
- Solder Paste Stencil: Make your own stencil with a gerber file provided by TopLine
- Pallets: Make your own pallet/fixture with a gerber file provided by TopLine
- Sn63/Pb37 Solder Paste: Kester EP256 or select your own ROL0 paste.
- Stencil Printer: Use your own solder paste stencil printer.
- Frequent ultrasonic cleaning to remove flux residue is recommended.
- Recommended to use vacuum vapor phase reflow oven (Solvay Galden LS-200°C) or 12-zone convection oven.

INFO

Graphite tool-set for attachment of solder columns and micro-coil springs for your specific package device.

Designed for ceramic and plastic Land Grid Array (LGA) substrates. The bottom base graphite holds the LGA substrate. The top graphite aligns the Flip-Pack cassettes pre-loaded with columns.

Place the bottom graphite in a pallet during solder paste stencil printing. White fiducials aid with alignment.

Using three graphite tool sets can increase volume up to 500 CGA packages per month. Just add more graphite tools to increase throughput to 10,000 packages per month. Tooling change-over for a new CGA device is quick.

www.CCGA.co/CCGA_Tool.html

Column Attachment Tool-Set for CCGA



Graphite System Aligns Columns on LGA Pad



X/Y Movable Stage Graphite Holds the LGA Package

INFO Graphite tool-set for attachment of solder columns and micro-coil springs for your specific package device. Designed for ceramic and plastic Land Grid Array (LGA) substrates. The stage and bottom base graphite holds the LGA substrate. The top Alignment Reticule Tool aligns LGA pads. Receptacle receives Flip-Pack cassettes pre-loaded with columns. Place the bottom graphite in a pallet during solder paste stencil printing. Fiducials aid with alignment.

www.CCGA.co/CCGA_Tool.html

C7-INSERT TOOL



Universal tool to hold and insert Flip-Pack into graphite tool. Place a Flip-Pack into cradle. Invert (flip-over) the C7-GRAPHITE tool upside down and place onto the C7-INSERT TOOL. Remove the insert tool. Load columns into the C7-GRAPHITE.

Part Number	Order#	Column Length
C7-INSERT-FP2-87	700011	2.21~2.54 mm
C7-INSERT-FP2-40	700040	1.0 mm
C7-INSERT-FP2-50	700050	1.27 mm
C7-INSERT-FP2-60	700060	1.5 mm

C7-EXTRACT TOOL

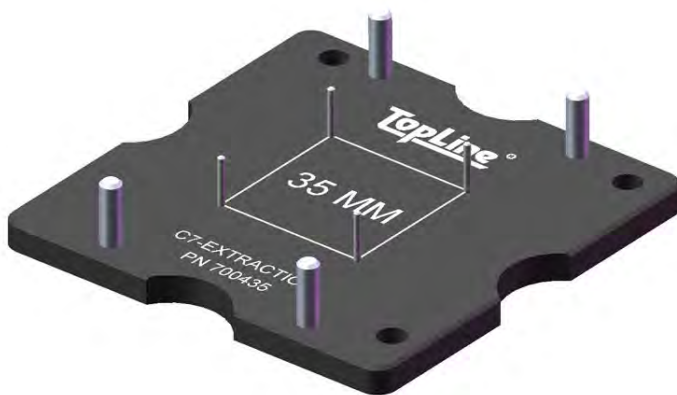

C7-EXTRACT tool removes the CCGA from C7-GRAPHITE and C7-PLANAR tools. Extraction pins positioned under 4 corners of the CCGA. Tool is specific for CCGA X/Y size.

Part Number	CCGA Size	Pitch
C7-EXTRACT-483-A	23mm	1.0mm
C7-EXTRACT-624-A	32.5mm	1.27mm
C7-EXTRACT-717-A	35mm	1.27mm
C7-EXTRACT-896-A	31mm	1.0mm
C7-EXTRACT-1152-A	35mm	1.0mm
C7-EXTRACT-1272-A	37.5mm	1.0mm
C7-EXTRACT-1657-A	42.5mm	1.0mm
C7-EXTRACT-1752-A	45mm	1.0mm

Contact TopLine for other sizes.

C7-EJECT TOOL



C7-EJECT is a simple to use tool to extract CCGA from Planarizing tool. Gently lifts substrate at 4-corners with precision dowel pins

Part Number	CCGA Size	Pitch
C7-EJECT-483-A	23mm	1.0mm
C7-EJECT-624-A	32.5mm	1.27mm
C7-EJECT-717-A	35mm	1.27mm
C7-EJECT-896-A	31mm	1.0mm
C7-EJECT-1152-A	35mm	1.0mm
C7-EJECT-1272-A	37.5mm	1.0mm
C7-EJECT-1657-A	42.5mm	1.0mm
C7-EJECT-1752-A	45mm	1.0mm

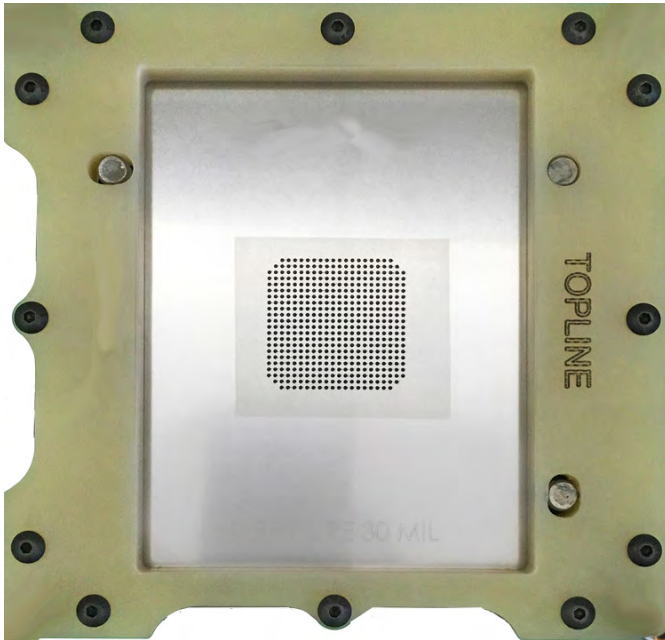

About Alignment Tool

Essential tool for centering and accurate X/Y Theta alignment of LGA in graphite. Includes precision alignment template with aperture allowing annular ring vision of LGA pads while seated in graphite stage.

Features:

- LGA package size: Up to 57x57mm
- Pitch: 1.0mm and 1.27mm and others
- Underside Recessed to clear solder paste
- Place over the Graphite Tool stage and base
- Set Includes frame and precision template

Exploded View

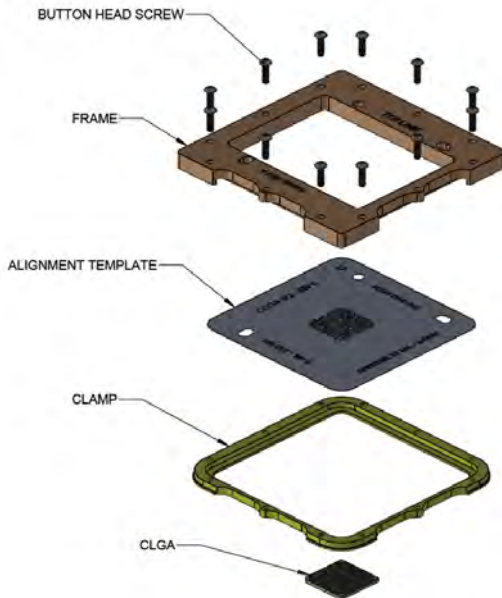

C7-ALIGN

Columns	Pitch	Row/Column	Order Code
483	1.0mm	22x22	212251
624	1.27mm	25x25	222542
1144	1.0mm	34x34	213482
1152	1.0mm	34x34	213460
1272	1.0mm	36x36	213670
1657	1.0mm	41x41	214160
1752	1.0mm	42x42	214270

Other Alignment Patterns Available

C7-TAMP

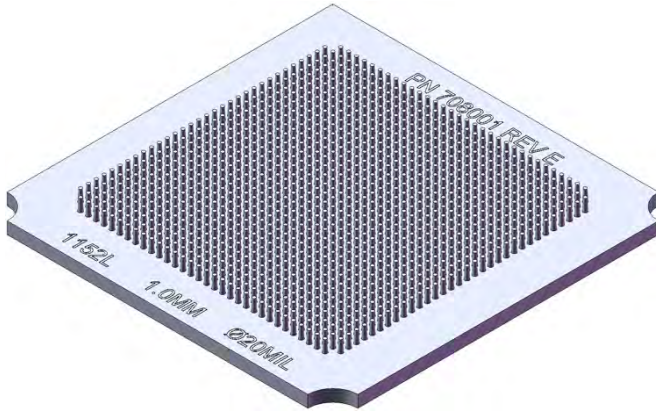

C7-TAMP is an array of Titanium (Ti) pins that gently push the solder columns uniformly into the solder paste on the substrate.

Part Number	CCGA Size	Pitch
C7-TAMP-143-A	14.5mm	1.0mm
C7-TAMP-255-A	21mm	1.27mm
C7-TAMP-360-A	25mm	1.27mm
C7-TAMP-399-A	21mm	1.0mm
C7-TAMP-483-A	23mm	1.0mm
C7-TAMP-624-A	32.5mm	1.27mm
C7-TAMP-717-A	35mm	1.27mm
C7-TAMP-896-A	31mm	1.0mm
C7-TAMP-1088-A	42.5mm	1.27mm
C7-TAMP-1136-A	35mm	1.0mm
C7-TAMP-1440-A	35mm	1.0mm
C7-TAMP-1144-A	35mm	1.0mm
C7-TAMP-1152-A	35mm	1.0mm
C7-TAMP-1272-A	37.5mm	1.0mm
C7-TAMP-1509-A	40mm	1.0mm
C7-TAMP-1657-A	42.5mm	1.0mm
C7-TAMP-1752-A	45mm	1.0mm

Contact TopLine for other sizes.



Solder Paste Printer C7-PRINTER

Telephone:
+1-800-776-9888

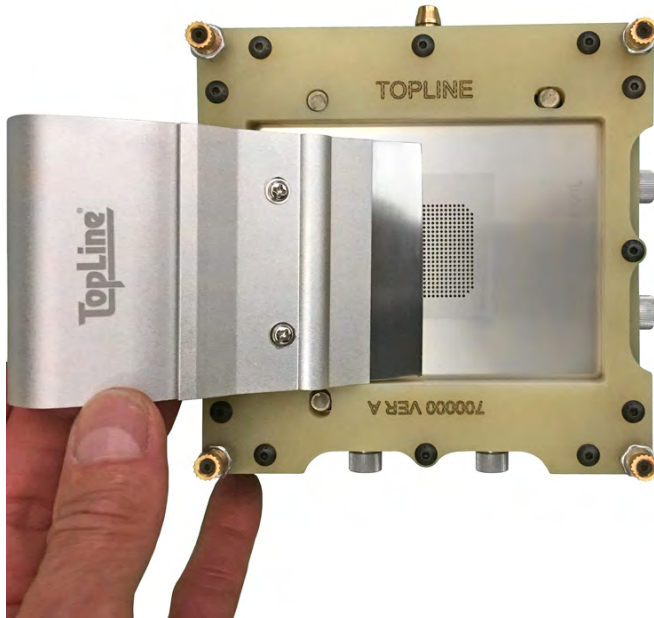

About C7-PRINTER

A complete manual stencil printer for attachment of solder columns and Micro-coil springs. Rugged construction. Mates directly onto TopLine's Graphite fixture. Expandable to your needs. Process volumes up to 500 CGA packages per month. Each C7-PRINTER includes a stencil frame, stencil clamp and hardware. Select 4.250" (108mm) stencils from TopLine to make your own system. Tooling change-over for a new device is less than 10 minutes.

Features:

- Benchtop size: 5"x5" (125x125cm) Square
- Power requirements: None
- Stencil Size: 4.25" SQ (108mm)
- Substrate size: 8mm to 45mm
- Includes: FRAME, CLAMP and Hardware.
- Stencil sold separately. See [Stencils](#)

Quick Change Stencils

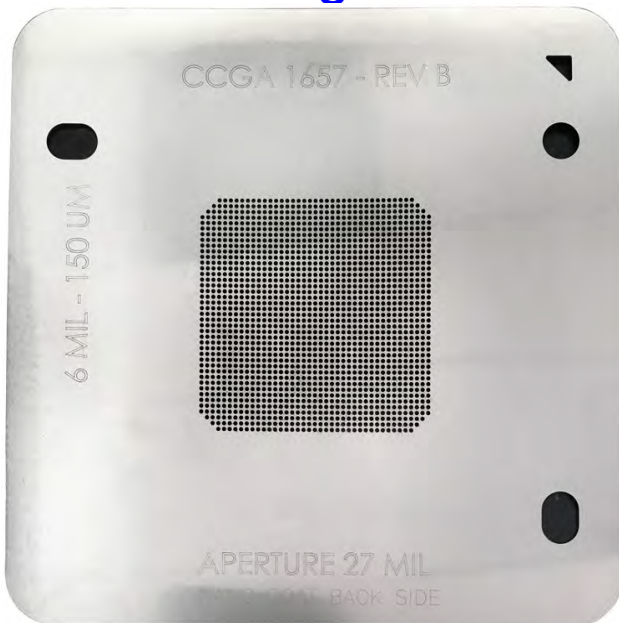

C7-ALIGN

Columns	Pitch	Row/Column	Order Code
483	1.0mm	22x22	212251
624	1.27mm	25x25	222542
1144	1.0mm	34x34	213482
1152	1.0mm	34x34	213460
1272	1.0mm	36x36	213670
1657	1.0mm	41x41	214160
1752	1.0mm	42x42	214270

Other Alignment Patterns Available

INFO

Contact TopLine for other optical alignment tools

www.CCGA.co/CCGA_Optic.html

Top View
Holds CCGA



Bottom View
Column Planarizing

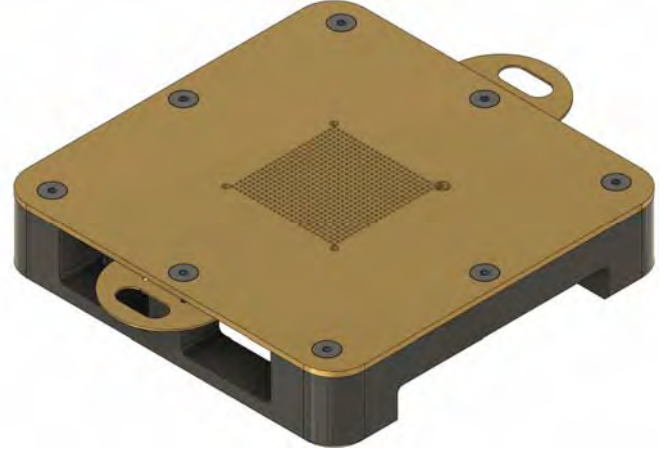

Hand Held COLUMN PLANARIZING TOOL

Securely locks the CCGA package. Place the CCGA inside of the tool. Adjust a single set screw until the tips of the columns slightly protrude 100um (4 mils) outside the brass plate. Hold tool with the brass plate face down on a rotating silicon carbide 240 grit (53um particle) abrasive lapping wheel at 150 RPM. Within seconds all columns are planarized. Last step use a 15um diamond polishing wheel to shine the tips of the columns.

Model Number	Substrate X/Y Size	Matrix Row x Col	Pitch	Column Ø Dia	Column Length Before Trim	Column Length After Trim
--------------	--------------------	------------------	-------	--------------	---------------------------	--------------------------

COMPLETE SET

C7-PLANAR-483-A	23mm	22 x 22	1.0mm	Ø 0.50mm	2.31mm (0.091")	2.21mm (0.087")
C7-PLANAR-624-A	32.5mm	25 x 25	1.27mm	Ø 0.50mm	2.31mm (0.091")	2.21mm (0.087")
C7-PLANAR-717-A	35mm	27 x 27	1.27mm	Ø 0.50mm	2.31mm (0.091")	2.21mm (0.087")
C7-PLANAR-1144-A	35mm	34 x 34	1.0mm	Ø 0.50mm	2.31mm (0.091")	2.21mm (0.087")
C7-PLANAR-1152-A	35mm	34 x 34	1.0mm	Ø 0.50mm	2.31mm (0.091")	2.21mm (0.087")
C7-PLANAR-1272-A	37.5mm	36 x 36	1.0mm	Ø 0.50mm	2.31mm (0.091")	2.21mm (0.087")
C7-PLANAR-1509-A	40mm	39 x 39	1.0mm	Ø 0.50mm	2.31mm (0.091")	2.21mm (0.087")
C7-PLANAR-1657-A	42.5mm	41 x 41	1.0mm	Ø 0.50mm	2.31mm (0.091")	2.21mm (0.087")
C7-PLANAR-1738-A	42.5mm	42 x 42	1.0mm	Ø 0.50mm	2.31mm (0.091")	2.21mm (0.087")
C7-PLANAR-1752-B	42.5mm	42 x 42	1.0mm	Ø 0.50mm	2.31mm (0.091")	2.21mm (0.087")
C7-PLANAR-1752-A	45.0mm	42 x 42	1.0mm	Ø 0.50mm	2.31mm (0.091")	2.21mm (0.087")

Why Trimming, Lapping and Polishing is required:

Copper wrapped Pb80/Sn20 columns are plated with hot Sn63/Pb37 solder. A reservoir of solder builds up between the windings of the copper ribbon. A solder bump will form at the free end of the column (see photos) during attachment of the columns to the CCGA substrate. The topography of the CCGA ceramic substrate is not flat. The thickness of the ceramic varies across the surface of the CCGA. It is necessary to planarize the free end of the solder columns after reflowing the columns to the CCGA substrate in order to compensate for variances in column lengths and ceramic thickness.

CCGA columns can be planarized using a jewelers faceting machine with an 8-inch (Ø200mm) diameter 150RPM rotating silicon carbide 240 grit paper (~53um particle). After lapping, the columns should be polished with 15um diamond polishing film. Alternately, trimming can be preformed using a pneumatic cutting blade.

Solder Bump
Top of Column



Free end
Solder Bump
Before Planarizing



Column Length Before Reflow	Column Length After Planarizing	Planarizing Method
2.21mm (87 mil)	2.11mm (83 mil)	Lap & Polish
*2.36mm (93 mil)	2.21mm (87 mil)	Lap & Polish
2.54mm (100 mil)	2.41mm (95 mil)	Lap & Polish
2.67mm (105 mil)	2.54mm (100 mil)	Lap & Polish
3.81mm (150 mil)	3.68mm (145 mil)	Lap & Polish

* Preferred column length for finished length 2.21mm

Top View
After Planarizing

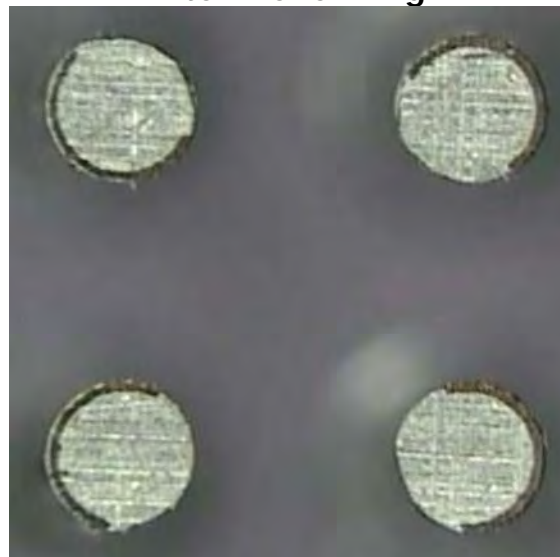

Model Number	Pins Max	Pitch	Pad Matrix	Package Size	Column Type	Device Type	Order Nr Blue Insert	Order Nbr Hinged Case Complete Set
EC1-2222E-2BC	484	1.0mm	22x22	23x23mm	All	CG484	031000	931429
EC1-2525F-2BC	624	1.27mm	25x25	32.5x32.5mm	All	CG624	032000	932259
EC1-2727F-2BC	717	1.27mm	27x27	35x35mm	All	CG717	032000	932279
EC1-3434E-2BB	1156	1.0mm	34x34	35x35mm	All	CG1152	034000	931345
EC1-3636E-2BB	1272	1.0mm	36x36	37.5x37.5mm	All	CG1272	034000	931365
EC1-4141E-2BB	1657	1.0mm	41x41	42.5x42.5mm	All	CG1657	034000	931415
EC1-4242E-2BB	1752	1.0mm	42x42	45x45mm	All	CG1752	034000	931425
EC1-4949E-2BB	2401	1.0mm	49x49	52.5x52.5mm	All	CG2401	034000	931495

Ask for other sizes available.





EC1 Series Box Pack

Universal carrier for transport and storage of individual CCGA package.
Columns are fully protected. The CCGA plastic insert seats into the die cut foam.
Top layer of conductive foam lightly compresses and holds the CCGA in place.

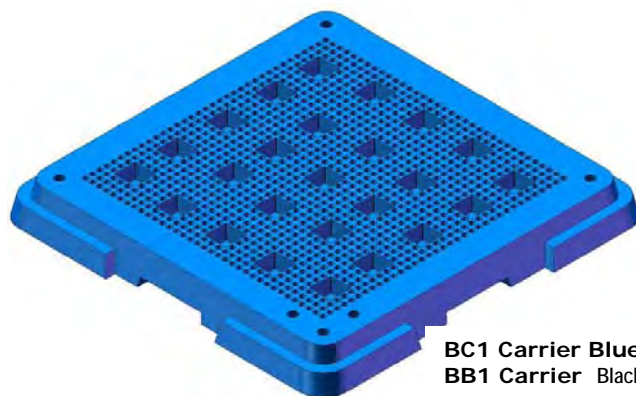
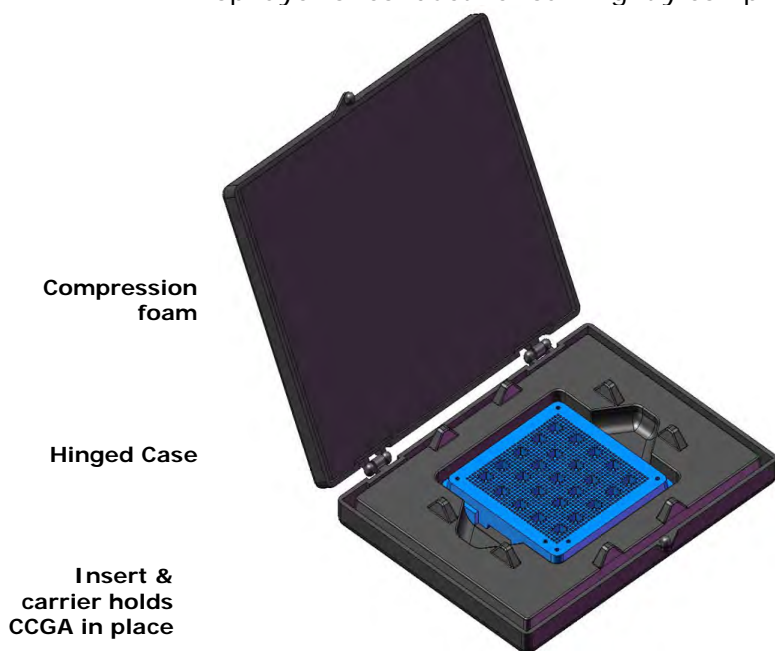
Features

- Number Columns: Up to 1752 Columns
- Column Length 100mil (2.54mm) Maximum
- Box Size: 4.75"x3.6"x.5" (120x92x12.7mm)
- CCGA size: Up to 45mm
- Pitch 1.0mm and 1.27mm

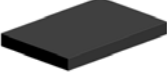

Model	Pins	Pitch	Matrix	Device Type	Description	DWG Nbr	Fig
EC1	All	All	All	Box Size I.D. 4.5" x 3.5" x 0.625"	Empty Hinge box without foam. Without Markings	900625	
EC1-INSERT	All	All	All	Universal Insert for 2.33" Carriers	Conductive Plastic	140110	
EC1-FOAM-SOFT	All	All	All	4.5x3.5x.125" 4.5x3.5x.250" 2.3x2.3x.125"	Soft black conductive foam Density 1.7 PFC Min Open-Cell Polyurethane Fits in top hinged box.	090006 090003 090011	
EC1-RUBBER-BAND 3.0C	All	All	All	3.0" x 0.5"	Black Conductive Rubber Band. Clamps individual box.	090005	
Ask for other sizes available.							

EC	1	- 1152	E	2	BB
-----	-----	-----	-----	-----	---
Series	Nbr Devices	Matrix	Pitch	Thickness	Option
EC = Tray Box 4.5x3.5"	<u>Code</u> • <u>Description</u>	<u>Code</u> • <u>Matrix</u>	<u>Code</u> • <u>Pitch</u>	<u>Code</u> • <u>Metric</u>	<u>Rev</u>
FR4 Insert Carrier	1 • Single Device	483 = 22x22	E • 1.0mm	1 • 1.5mm (0.060")	BB
PA = Insert 1.8" x 1.8"		624 = 25x25	F • 1.27mm	2 • 2.3mm (0.093")	BC
PB = Insert 2.33" x 2.33"	JEDEC Outline	717 = 27x27		3 • 3.0mm (0.125")	
PC = Insert 4.55" x 3.45"	8 • 8 Devices	1152 = 34x34	Y • 1.17/1.09mm	4 • 4.7mm (0.187")	
Carrier	10 • 10 Devices	1272 = 36x36	Z • Other	6 • 6.3mm (0.250")	
BB = 2.33" x 2.33" BLACK	12 • 12 Devices	1657 = 41x41		8 • 1.2mm (0.047")	
BC = 2.33" x 2.33" BLUE		1752 = 42x42			

Tray System DWG Nbr

9	3	1	34	5
-----	-----	-----	-----	-----
Column Alloy	Construction	Pitch	Array	Thickness
<u>Code</u> • <u>Description</u>	<u>Code</u> • <u>Description</u>	<u>Code</u> • <u>Pitch</u>	<u>Code</u> • <u>Matrix</u>	<u>Code</u> • <u>Metric</u>
0 = Packaging Accessories	9 = Hinged Box 4.5" x 3.5"	1 = 1.0mm	22 = 22x22	0 • LGA No Columns
9 = Complete Tray Box Set	CARRIERS	2 = 1.27mm	25 = 25x25	1 • 1.5mm (0.062")
	2 = 1.78"SQ (45.2mm) PA	8 = 0.80mm	26 = 26x26	2 • 2.3mm (0.093")
	3 = 2.33"SQ (59.2mm) PB	9 = Custom	26 = 27x27	3 • 3.2mm (0.125")
	4 = 4.5"x3.5" (115x88mm) PC		30 = 30x30	8 • 1.2mm (0.047")
	<u>Code</u> • <u>Description</u>		34 = 34x34	0 = Master
	7 = JEDEC Outline Tray		36 = 36x36	
	1 = 12" x 5" Insert		41 = 41x41	7=2.3mm (0.091")
	0 = Empty Flip-Pack		42 = 42x42	Clear ESD Polycarbonate
			49 = 49x49	
				4 = Blue Carrier w/insert
				9 = Blue Carrier Anti-static
				5 = Black Carrier Conductive

Solders

Alloy	Solidus	Liquidus	Density gm/cm ³	Modulus of Elasticity	Electrical Conductivity % of IACS	Thermal Conductivity	CTE Coefficient Thermal Expansion	Tensile Strength
Pb95/Sn5 Solder	312°C	305°C	11.0	20 GPa	8.0	36 W/m-K	28.7ppm/°C	23 MPa
Pb93.5/Sn5 /Ag1.5 HMP	296°C	301°C	10.8	19.5 GPa	8.7	36 W/m-K	28.7ppm/°C	29.6 MPa
Pb90/Sn10 Solder	275°C	302°C	10.5	19.0 GPa	8.2	36 W/m-K	27.9ppm/°C	30 MPa
Pb85/Sn15 Solder	226°C	290°C	10.4	19.5 GPa	8.5	36 W/m-K	27.0ppm/°C	32 MPa
Pb80/Sn20 Solder	183°C	280°C	10.2	20 GPa	8.7	37 W/m-K	26.5ppm/°C	33 MPa
Sn60/Pb40 Solder	183°C	186°C	8.5	30 GPa	11.5	50 W/m-K	23.9ppm/°C	52 MPa
Sn63/Pb37 Solder	183°C	183°C	8.4	30 GPa	11.9	51 W/m-K	24.0ppm/°C	52 MPa
SAC305 Sn96.5/Ag3.0/Cu0.5 Solder	217°C	220°C	7.4	51 Gpa	16.6	59 W/m-K	23.5ppm/°C	50 Mpa
SCN305 Sn96.5/Cu3.0/Ni0.5 Solder	228°C	394°C	7.3	48 Gpa	13.0	50 W/m-K	22ppm/°C	40~60 Mpa
Sn90/Sb10 Sn90/Sn10 Solder	243°C	257°C	8.4	__ Gpa	10.7	49W/m-K	27ppm/°C	42 Mpa

Metric Units of GPa are Gigapascals (10⁹ Pa) • Metric Units of MPa are Megapascals (10⁶Pa)
Data is for information only and is not guaranteed for accuracy.

Other Columns

Alloy	Solidus	Liquidus	Density gm/cm ³	Modulus of Elasticity	Electrical Conductivity % of IACS	Thermal Conductivity	CTE Coefficient Thermal Expansion	Tensile Strength
Copper CDA101 OFHC-101	1083°C	1083°C	8.94	115 GPa	60MΩ m	400 W/m-K	17.0ppm/°C	221 MPa
Beryllium Copper	--	865°C	8.36	131 GPa	22~28	105 W/m-K	17.5ppm/°C	1100 MPa

Metric Units of GPa are Gigapascals (10⁹Pa) • Metric Units of MPa are Megapascals (10⁶Pa)
Data is for information only and is not guaranteed for accuracy.

Metals in Substrates

Alloy	Thermal Conductivity @ 25°C	CTE Coefficient Thermal Expansion	Electrical Resistance	Specific Gravity
Alloy 42	10.5 W/mK	5.0ppm/°C	72 * 10 ⁻⁶ Ω-cm	8.1 g/cc
Kovar	16.7 W/mK	5.9ppm/°C	49 * 10 ⁻⁶ Ω-cm	8.4 g/cc
Alloy C194 Copper	260 W/mK	9.8ppm/°C	1.7 * 10 ⁻⁶ Ω-cm	8.9 g/cc
Tungsten (W)	173 W/mK	4.5ppm/°C	5.5 * 10 ⁻⁶ Ω-cm	19.3 g/cc
Molybdenum	138 W/mK	5.1ppm/°C	5.2 * 10 ⁻⁶ Ω-cm	10.2 g/cc

Ceramic Al₂O₃ Substrates

Material	Density gm/cc	Hardness	Flexural Strength	Young's Modulus	Shear Modulus	Thermal Conductivity @25°C	CTE Coefficient Thermal Expansion	Volume Resistivity	Dielectric Constant D _k	Dissipation Factor D _f
HTCC Ceramic Al ₂ O ₃ Alumina 92%	3.62 g/cc	1027 Kg/mm ²	443 MPa	275 GPa	112 GPa	20.3 W/mk	6.6 ppm/°C	>10 ¹⁴ Ω-cm ² /cm	9.2 ε _r	0.0003 δ @1MHz

HTCC = High Temperature Co-fired Ceramic

Material Properties Heat sinks

Material	Density gm/cc	Specific Heat	Flexural Strength	Young's Modulus	Shear Modulus	Thermal Conductivity @25°C	CTE Coefficient Thermal Expansion 20~150°C	Electrical Resistance
Al-SiC 37% Aluminum Alloy A356.2 63% Silicon Carbide	3.01 g/cc	0.741 J/gK @25°C	488 MPa	188 GPa	76 GPa	200 W/mk Typical	8.4 ppm/°C	20.7 μΩ-cm

Al-SiC = Aluminum Silicon Carbide.

Recommended Usage CBGA Ball vrs CCGA Column Acceptable Strain (Deformation)

Substrate Size (X/Y)	Distance Corner to Corner	DNP Distance from Neutral Point	Change in Temperature					
			$\Delta 50^{\circ}\text{C}$	$\Delta 75^{\circ}\text{C}$	$\Delta 100^{\circ}\text{C}$	$\Delta 125^{\circ}\text{C}$	$\Delta 150^{\circ}\text{C}$	$\Delta 165^{\circ}\text{C}$
			Recommended Package Type Usage					
5mm	7.1mm	3.5	Solder Ball	Solder Ball	Solder Ball	Solder Ball	Solder Ball	Solder Ball
10mm	14.1mm	7.1	Solder Ball	Solder Ball	Solder Ball	Solder Ball	Solder Ball	Solder Ball
12mm	17.0mm	8.5	Solder Ball	Solder Ball	Solder Ball	Solder Ball	Solder Ball	Solder Ball
15mm	21.2mm	10.6	Solder Ball	Solder Ball	Solder Ball	Solder Ball	Solder Ball	Solder Ball
21mm	29.7mm	14.8	Solder Ball	Solder Ball	Solder Ball	Solder Ball	Ball / Column	Ball / Column
23mm	32.5mm	16.3	Solder Ball	Solder Ball	Solder Ball	Ball / Column	Ball / Column	Ball / Column
25mm	35.4mm	17.7	Solder Ball	Solder Ball	Solder Ball	Ball / Column	Ball / Column	Ball / Column
27mm	38.2mm	19.1	Solder Ball	Solder Ball	Solder Ball	Ball / Column	Ball / Column	Column
31mm	43.8mm	21.9	Solder Ball	Solder Ball	Ball / Column	Ball / Column	Ball / Column	Column
32.5mm	46.0mm	23.0	Solder Ball	Solder Ball	Ball / Column	Ball / Column	Column	Column
35mm	49.5mm	24.8	Solder Ball	Solder Ball	Ball / Column	Ball / Column	Column	Column
37.5mm	53.0mm	26.5	Solder Ball	Solder Ball	Ball / Column	Column	Column	Column
40mm	56.6mm	28.3	Solder Ball	Ball / Column	Ball / Column	Column	Column	Column
42.5mm	60.1mm	30.1	Solder Ball	Ball / Column	Column	Column	Column	Column
45mm	63.6mm	31.8	Solder Ball	Column	Column	Column	Column	Column
52.5mm	74.3mm	37.1	Column	Column	Column	Column	Column	Column

COLOR CODE:	CBGA CERMIC PACKAGE	CCGA COLUMN CERAMIC PACKAGE
GREEN	Safe to use CBGA	MARGINAL IMPROVEMENT with Columns
YELLOW	Use caution with Solder Ball	LONGER OPERATING LIFE with Columns
RED	Solder Ball Not Recommended	Use CCGA Column ONLY

Table shows the safe and unsafe sizes of Ceramic Ball Grid Array (CBGA) after mounting to a FR4 board. The green highlighted areas (CBGA allowed) indicates acceptable ball deformation up to 25um (1.0mil). The yellow highlighted areas (CBGA will eventually fail) indicates ball deformation up to 38um (1.5mil). The orange highlighted areas (CBGA will immediately fail) due to excessive ball deformation. Only Column Grid Arrays (CCGA) should be used in the orange highlighted area.

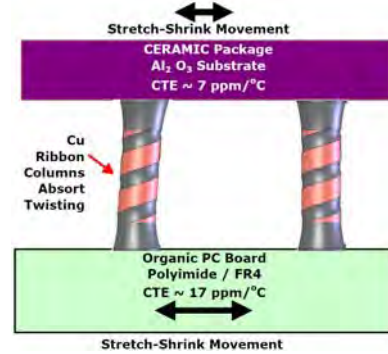
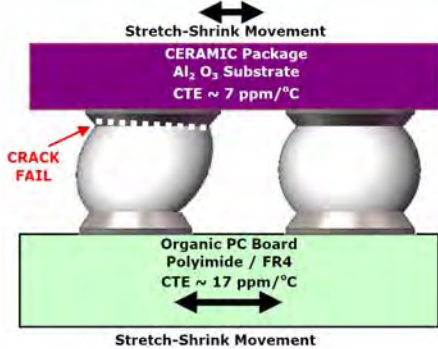

INFO

CTE mismatches causes ceramic BGA solder balls to deform over wide temperature swings. Large ceramic BGA will delaminate from FR4 (polyimide) PCB after many temperature cycles. CCGA solder columns are compliant and will absorb stress caused by CTE mismatch.



Technical CCGA Library Download Documents

Telephone:
+1-800-776-9888

More technical papers available for download
www.CCGA.co/CCGA_Library.html

Ref	Title	Company	Author	Year Pub.
0	CCGA Assembly & Market	TopLine Corporation	Martin Hart	2014
1	Solder Columns Space Parts Working Group	TopLine Corporation	Martin Hart	2014
2	Reliability of CGA/LGA/HDI Package Board/Assembly	NASA JPL Jet Propulsion Laboratory	Reza Ghaffarian, Ph.D.	2012
3	Micro-coil Spring interconnects for Ceramic Grid Array Integrated Circuits	NASA - Marshal Space Flight Center	Mark Strickland Jimmy Hester J.F. Blanche T.S. Nash	2011
4	Study of Ceramic Column Grid Array Components for Space Systems	Northop Grumman	Jonathan Fleisher Walter Willing	2011
5	Ceramic Column Grid Array Design and Manufacturing Rules for Flight Hardware	NASA Goddard Space Flight Center	GSFC-STD-6001	2011
6	Reliability of High I/O High Density CCGA Interconnect Electronic Packages under Extreme Thermal Environments.	NASA JPL Jet Propulsion Laboratory	Rajeshumi Ramesham, Ph.D.	2011
7	Reliability of CCGA Under Extreme Temperature for Space Applications	NASA JPL Jet Propulsion Laboratory	Rajeshumi Ramesham, Ph.D.	2010
8	Thermal Performance of Micro-Springs in Electronic Systems	NASA Marshall Space Flight Center	Allison Copus Reviewed by Jeff Brown	2009
9	Thermal Cycle Reliability Failure Mechanisms CCGA and PBGA With and Without Corner Staking	NASA JPL Jet Propulsion Laboratory	Reza Ghaffarian, Ph.D.	2008
10	Column Grid Array Rework For High Reliability	NASA JPL Jet Propulsion Laboratory	Atul Mehta & Charles Bodie	2008
11	Solder Column Qualification for Ceramic Column Grid Array (CCGA)	Aeroflex	Author not cited	2008
12	Atmel CCGA625 Mounting Evaluation	SAAB	Stanley Mattsson	2007
13	CCGA packages for space applications	NASA JPL Jet Propulsion Laboratory	Reza Ghaffarian, Ph.D.	2006
14	Design Parameters Influencing Reliability of CCGA Assembly: A Sensitivity Analysis	NASA JPL Jet Propulsion Laboratory	Reza Ghaffarian, Amaneh Tasooji, Antonio Rinaldi	2005
15	Comparison of X-Ray Inspection Systems of BGA/CCGA Quality Assurance and Crack Detection	NASA JPL Jet Propulsion Laboratory	Reza Ghaffarian, D. Mih	2005
16	Reliability Testing and Data Analysis of an 1657 CCGA (Ceramic Column Grid Array) Package with Lead-Free Solder Paste on Lead-Free PCBs (Printed Circuit Boards)	Agilent Technologies	Author not cited	2004
17	JEDEC Standard MO-158D	JEDEC	JEDEC JC-11 Committee	2002
18	JEDEC Standard MO-159B	JEDEC	JEDEC JC-11 Committee	1999
19	Solder Column CCMD Test Report on Serial Thermal Cycle, Shook, and Vibration Tests	Raychem	-	1987



Authorized Distributors CCGA Products

EUROPE

Belgium & The Netherlands

Rotec
Tel +32 (0) 14 40 21 50
info@rotec.be

Italy (North)

Cepeitalia
Tel +39 02-4073747
info@cepeitalia.it

Sweden

TopLine
Tel +1-478-451-5000
info@topline.tv

Finland

Koodiportii Oy
Tel +358 (040) 5479 338
Jarno.pyoria@koodiportti.com

Italy (South)

Cepe Forniture
Tel +39 075.95.61.86
cepeelettronica@virgilio.it

Switzerland

Hilpert electronics AG
Tel +41 (0)56 483 25 25
office@hilpert.ch

France

ATOO electronics
Tel +33 (02) 99.08.01.90
info@atoo-electronics.com

Poland

Semicon
Tel +48 (22) 615-6431
info@semicon.com.pl

Turkey

Factronix
Tel +90 (0)362-54-391-23
s.yamanlar@factronix.com

Germany & Austria

Factronix
Tel +49 8153-90 664-0
office@factronix.com

Spain

Necten
Tel +34 916 942 409
necten@necten.com

United Kingdom

Kaisertech
Tel +44-(0)23-8065-0065
sales@kaisertech.co.uk

Ireland

IPP Ltd
Tel +353 (21) 423 2233
sales@ippgroupLtd.com

Middle East and Africa

Israel

G-Suit
Tel +972 (08)-910-8878
G-Suit@TopLine.tv

South Africa

Test & Rework
Tel +27-11-704-6677
sales@testandrework.co.za



Authorized Distributors CCGA Products

Telephone:
+1-800-776-9888

ASIA

Hong Kong

Borison Automation
Tel +852 2687-0948
TopLine@borison.com

India

EMST Marketing Pvt. Ltd
Tel +91 95 955 2 5010
contact@emstoline.com

Malaysia

Dou Yee Enterprises
Tel +65-6444-2678
marketing@douyee.com

China

Jamron
Tel +86-21-5109 7866
info@jamron.com

Japan

ADY
Tel +81-06-6397-0412
TopLine@ADY-jp.com

Singapore

Dou Yee Enterprises
Tel +65-6444-2678
marketing@douyee.com

Korea

Jin Trading
Tel +82 (031) 499-5633
Jeong6651@naver.com

Taiwan

Zinby
Tel +886-2-8228-0880
Sales1@zinby.com.tw

Americas

Argentina

TopLine
Tel +1-478-451-5000
info@TopLine.tv

Brazil

TopLine
Tel +1-478-451-5000
info@TopLine.tv

Canada, USA, Mexico

TopLine
Tel +1-478-451-5000
info@TopLine.tv

TopLine®

1-800-776-9888

info@TopLine.tv

www.CCGA.co

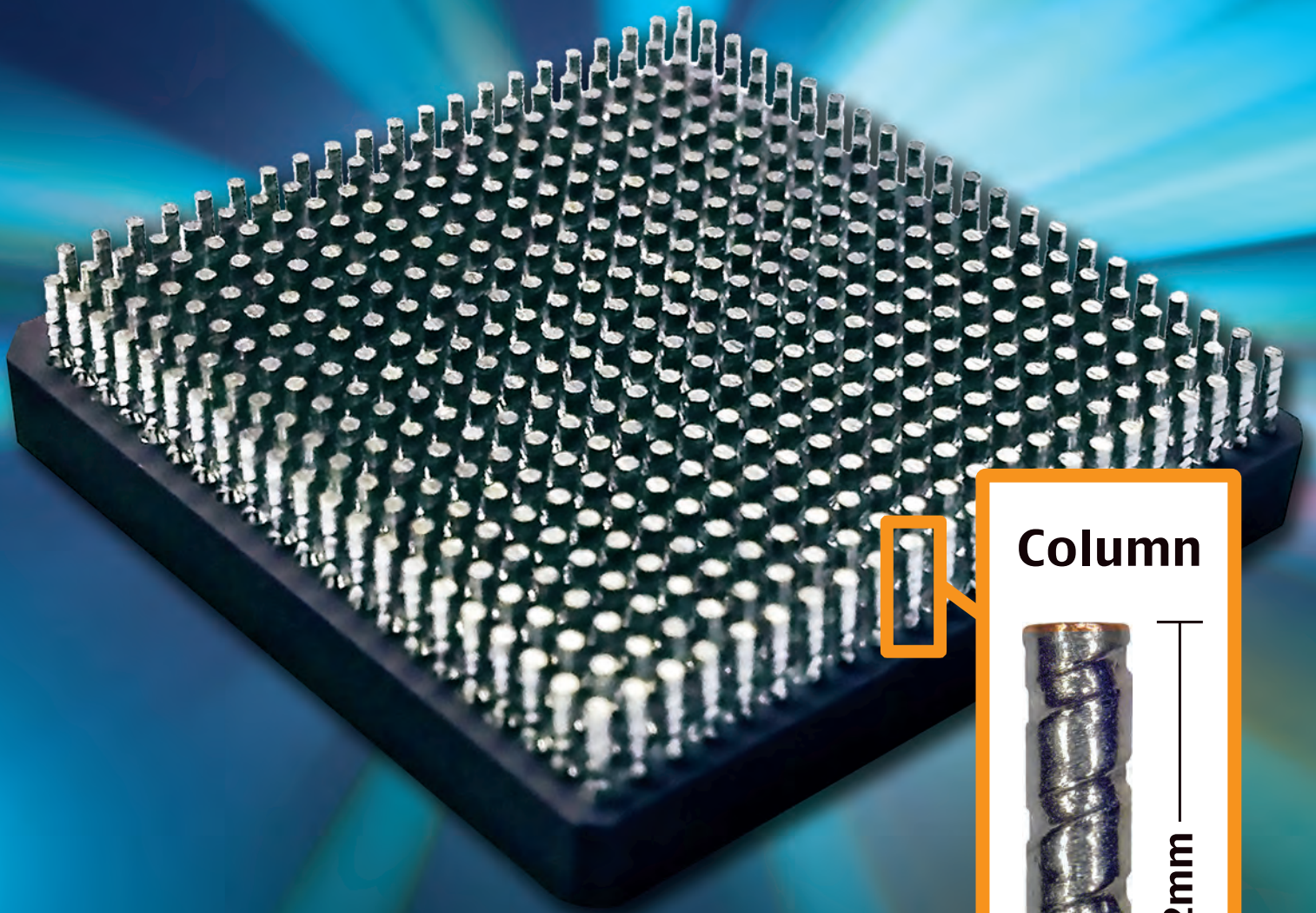

Column



2.2mm

**Solder Columns • Cu Pillars
Daisy Chain • Attachment Tools**