

SECTION VIEW

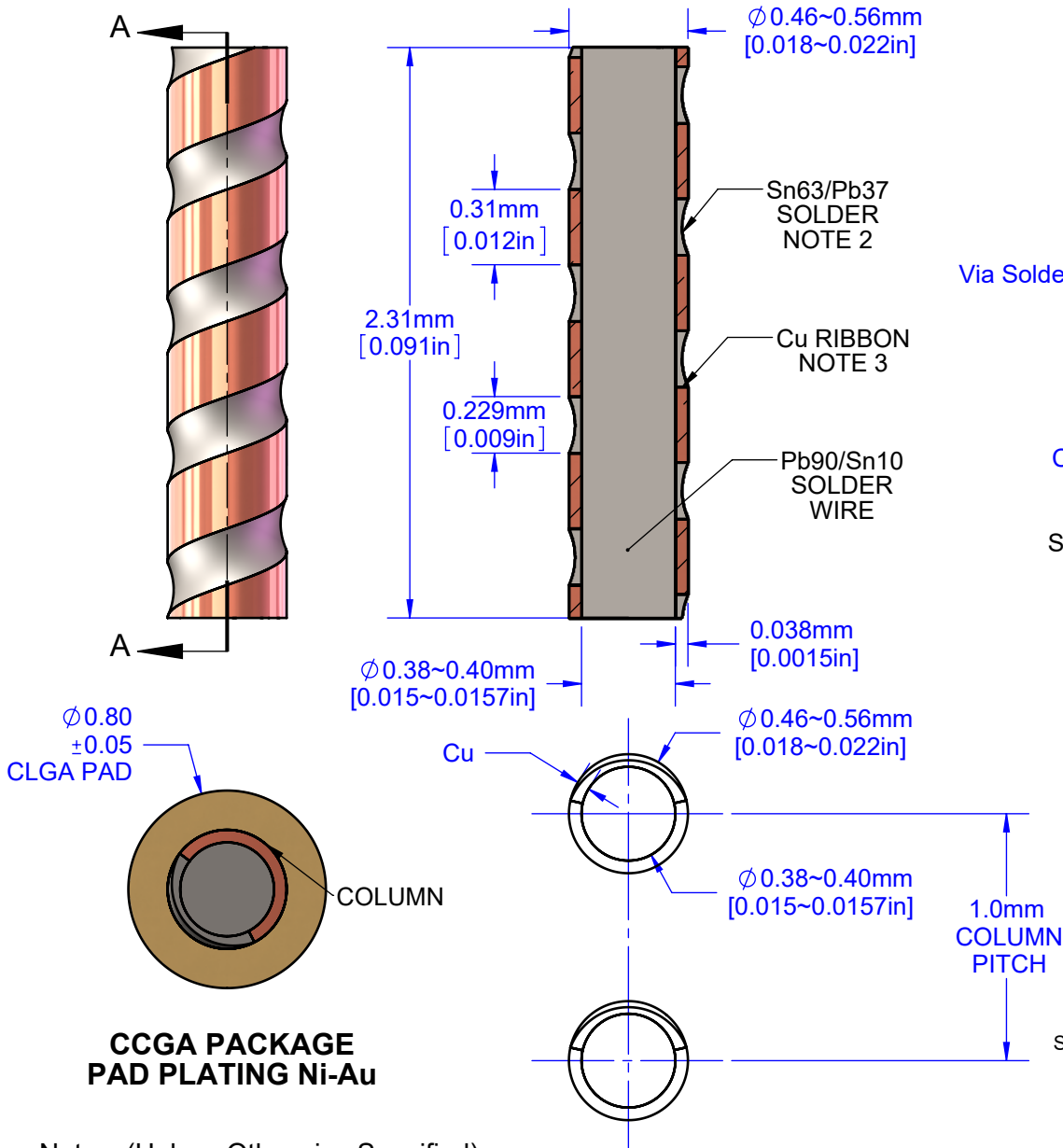

PCB LAND PATTERN (NOTE 4)

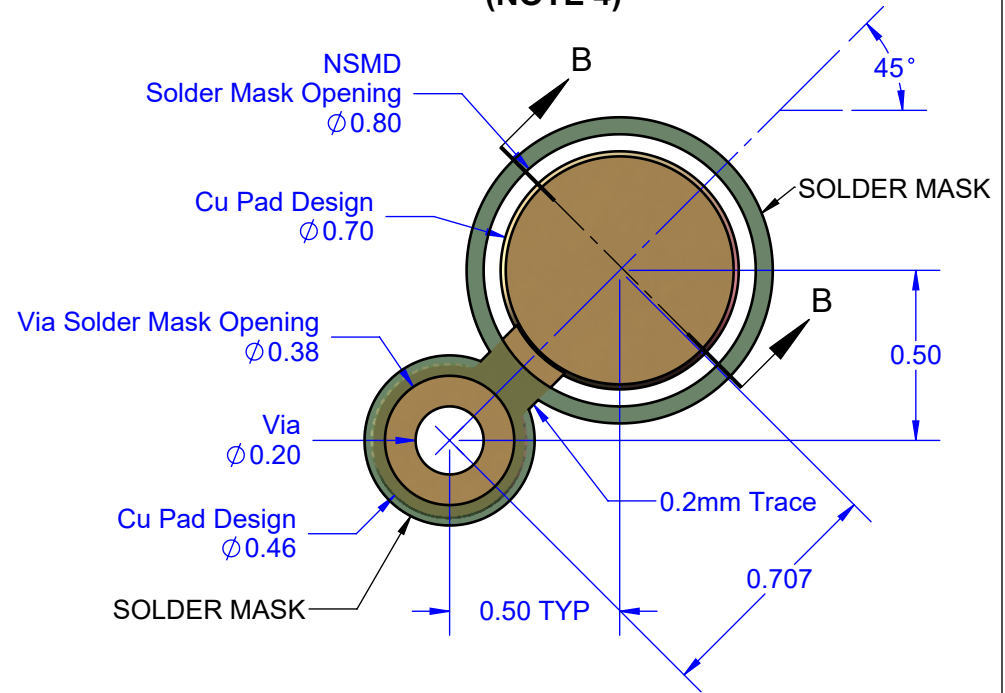

Cu PAD SIDE VIEW

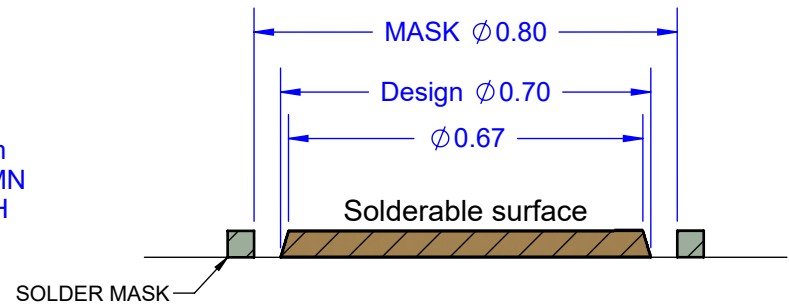

Section B-B

APPROVALS	DATE	TopLine®			
DRAWN T. Au	03/29/16				
ENG M. Hart	03/29/16	TITLE CG9010C20x91 CCGA SOLDER COLUMN			
MFG		SCALE	SIZE	DRAWING NO.	REV
QA		35:1	A	912091	A
CUST		DO NOT SCALE DRAWING			SHEET 1 OF 1
REVISED					

Notes: (Unless Otherwise Specified).

- 1) DIMENSIONS IN mm [INCHES].
- 2) THICKNESS Sn63/Pb37 SOLDER COAT 6~25 μm [0.25~1.0mil].
- 3) Cu ALLOY C10100 - OFE (CDA-101). 99.99% PURE.
- 4) PCB BOARD DIMENSIONS ARE PRESENTED ONLY AS A GUIDELINE. DESIGNERS SHOULD USE THEIR OWN EXPERIENCE WHEN DESIGNING PCB.